



Celia Bingham

# Technical English

SECOND EDITION

1

Teacher's book



**York Press Limited**

322 Old Brompton Road,  
London SW5 9JH,  
England

**Pearson Education Limited**

KAO Two  
KAO Park  
Hockham Way  
Harlow, Essex  
CM17 9SR  
England

and Associated Companies throughout the world.

pearsonenglish.com

© York Press Limited and Pearson Education Limited 2023

Written by Celia Bingham

The right of Celia Bingham to be identified as author of this Work has been asserted by her in accordance with the Copyright, Designs and Patents Act 1988

All rights reserved; no part of this publication may be reproduced, stored in a retrieval system, or transmitted in any form or by any means, electronic, mechanical, photocopying, recording, or otherwise without the prior written permission of the Publishers.

First published 2008

Second edition 2022

This edition York Press Limited and Pearson Education Limited 2023

ISBN: 978-1-80452-887-7

Set in Source sans pro-Light

**Acknowledgements**

Illustrated by Mark Duffin, Peter Harper and HL Studios

**Cover Image: Getty Images:** morkeman/E+

All other images © Pearson Education

# Contents

|  |          |
|--|----------|
| <b>Introduction</b>                    | page 4   |
| <b>Unit 1 Check-up</b>                 | page 7   |
| <b>Unit 2 Parts (1)</b>                | page 15  |
| <b>Review Unit A</b>                   | page 23  |
| <b>Unit 3 Parts (2)</b>                | page 27  |
| <b>Unit 4 Movement</b>                 | page 35  |
| <b>Review Unit B</b>                   | page 43  |
| <b>Unit 5 Flow</b>                     | page 47  |
| <b>Unit 6 Materials</b>                | page 55  |
| <b>Review Unit C</b>                   | page 63  |
| <b>Unit 7 Specifications</b>           | page 67  |
| <b>Unit 8 Reporting</b>                | page 75  |
| <b>Review Unit D</b>                   | page 83  |
| <b>Unit 9 Troubleshooting</b>          | page 87  |
| <b>Unit 10 Safety</b>                  | page 95  |
| <b>Review Unit E</b>                   | page 103 |
| <b>Unit 11 Cause and effect</b>        | page 107 |
| <b>Unit 12 Checking and confirming</b> | page 115 |
| <b>Review Unit F</b>                   | page 123 |
| <b>Word list</b>                       | page 127 |



## Introduction

**Technical English** is a four-level course for students in technical or vocational education and for company employees in training at work. It covers the core language and skills that students need to communicate successfully in a wide range of technical and industrial specialisations. **Level 1** is for students with a basic knowledge of general English who require an elementary course in English for specific purposes. This is benchmarked against CEFR level A1, and has been mapped to GSE 20–32.

**Level 2** is for students who have completed Level 1, or have an elementary knowledge of general English, and now require a pre-intermediate course in English for specific purposes. This is benchmarked against CEFR level A2, and has been mapped to GSE 30–44. **Level 3** is for students who have completed Level 2, or have a pre-intermediate knowledge of general English, and now require an intermediate course in English for specific purposes.

This is mapped to CEFR level B1–B2, or 43–61 on the GSE.

**Level 4** is for students who have completed Level 3, or have a good intermediate knowledge of general English, and now require an upper-intermediate course in English for specific purposes. This is mapped to CEFR level B2+–C1, or 60–80 on the GSE.

The course uses a multi-thread syllabus consisting mainly of communicative functions, notions, grammar, vocabulary and skills. The work-specific communicative functions (e.g. *meeting and greeting people, exchanging information*) and technology-specific notions or concepts (e.g. *direction of movement, using an instruction manual*) are selected on the basis of relevance to the needs of students in technical, training and work contexts. Exponents of functions and notions are selected on the basis of frequency and relevance to needs. In Level 1 the grammar is sequenced; in Levels 2–4 a more cyclical approach is taken, in which functions and notions re-appear with more complex grammatical exponents.

The vocabulary of the course is a selection of common-core lexical items that have a high frequency of use across a range of technical and industrial contexts. Many of these items can be found in general contexts, but have a greater frequency and often a more specific meaning in technical contexts. Many of them are the kinds of words which a specialist in one field might use to explain technical concepts and specialised terms to the general public, or to specialists in other fields.

The methodology is transparent and straightforward, with a practical task-based approach. Activities are firmly rooted in shared meanings and clear contexts. The approach recognises that the students may have differing motivations towards learning English, but assumes that they have a knowledge of, and interest in, technology and wish to develop their careers and technical skills. The topics and texts reflect current and future developments in technology, and are designed to stimulate students' interest and motivation to find out more about them. From the beginning of the course, students are encouraged to use their technical knowledge and problemsolving skills.

## Course Book 1

The Course Book contains 12 core units and 6 Review Units. Each core unit is divided into three sections. Each section (corresponding approximately to a 60–90 minute lesson) is contained on two facing pages, unified by a single theme, which may be a function, a concept or a topic. There is a four-page review unit after every two core units.

### Core units

#### Start here

This is a warm-up activity which begins each double-page section. It may be a question (based on a picture or diagram) for pairs or groups to discuss before they begin a reading or a listening activity.

#### Listening

Listening skills are developed through a variety of activities using audio texts set in both work and training contexts. The listening activity requires students to carry out a practical task during or after listening, such as labelling a diagram, filling in a form or physically carrying out an instruction. Audio texts set in work contexts include meeting and greeting, following instructions, sports results, customer/shopkeeper scenario, TV advert, technical descriptions and customer services. Before students are expected to carry out any listening activity, they are given some background information and often carry out a small preparatory task (in the **Start here** activity) to set the context and encourage them to listen actively. For example, in some cases they answer a quiz from their own knowledge, and then listen to a passage which contains the answers.

#### Speaking

Speaking is an important skill, whether the user is talking to colleagues at work, dealing effectively with customers seeking advice or technical support, or in interactive training contexts such as tutorials or technical demonstrations. Speaking tasks in Course Book 1 reflect real-world situations, such as giving information, comparing products, using technical information, following instructions (such as in a driving lesson), describing what people are doing or explaining how something works (such as a burglar alarm). At this level, students are also guided towards giving short and simple talks based on diagrams. Speaking activities are conducted in pairs, small groups or individually to the class. In addition, the **Task** section (see over) includes information-gap activities.

## Reading

Reading is a key skill needed by technologists both in the training context and at work. The texts they have to process in real life can vary enormously in length, complexity and genre. Readers' purposes vary from in-depth understanding to following instructions or searching for statistics. The reading texts in Course Book 1 reflect real-life texts and purposes, and are all based on authentic sources. These sources include specification texts and charts, user manuals, interviews, safety information and newspaper articles. Labelled diagrams and photographs are liberally provided to aid comprehension of technical data, and students are always given some background information or asked to think about a topic (often in the **Start here** activity) before they start reading, so that they are using the texts actively. For example, they may be asked to label a photograph *before* reading further about the topic. The texts use carefully controlled language and are accompanied by simple and practical tasks such as checking information, labelling a diagram, correcting details or completing a specification chart. Simple activities which highlight the use of cohesive devices and discourse markers are introduced gradually at this level. (Scanning or speed reading activities are introduced in Course Book 2.)

## Writing

Writing skills are developed through a variety of tasks in realistic contexts, reflecting the range of text types which students might have to produce in a work context or as part of their technical training. Writing activities in a work context include completing forms, comparing products, writing instructions or a troubleshooting guide or a report. Activities in a training or educational context include writing simple technical descriptions of devices and how they work. In addition, the **Task** section (see below) includes writing activities.

## Task

The **Task** section provides students with opportunities to combine and use their language, skills and technical knowledge to communicate in situations that reflect the world of work or technical training. Tasks require different combinations of skill, knowledge and procedure. Some are, in fact, problem-solving or cognitive exercises designed to activate their background knowledge to help them in a reading, writing, listening or speaking activity. Others (normally coming at the end of a section) combine one or more skills, often as information-gap activities where one student of a pair uses data in the **Extra material** section at the back of the book (see below). Examples of tasks include identifying how to assemble a skateboard or make predictions how a device will work. Some tasks can be done individually, but most are done in pairs or small groups.

## Language

The language box draws students' attention to the key grammar of a lesson. The grammar is presented in a simple, straightforward manner and gives only the basic minimum of information necessary. The box is intended for reference or study only, and always follows a reading or listening activity in which the student has understood the grammar point in context. Where necessary, the language box is accompanied by a short language practice exercise. If students need more information about grammar, or for revision, they can refer to the **Grammar summary** at the back of the Course Book.

## Vocabulary

Vocabulary activities develop students' knowledge and use of common core technical or sub-technical vocabulary. Many activities use visuals to clarify the parts of an item, such as a skateboard. Other activities deal with lexical sets, word families and affixes (e.g. *parts of tools*, *movement (ascend, descend)*, *currency*). Some pronunciation work on syllable stress (e.g. *titanium*, *fibreglass*) is covered here. Students are made aware of words that are used across several specialisms (e.g. *deck*) and everyday words that take on special meanings in technical contexts (e.g. *jaws*).

## Social English

Most core units in Course Book 1 include a short activity practising the language from the unit in a social/professional context. (In Course Book 2 social language is integrated into conversations between work colleagues and does not appear as a separate feature.)



## Reference

### Language summary

This gives more information about all the language points dealt with in the core units. It can be used as a reference during a lesson or for revision.

### Reference section

This section at the back of the book includes useful reference material for the student, for example, units of measurement and their abbreviations, numbers, times and dates, some common electrical and safety symbols, British and American English and social, telephone and email phrases.

### Extra material

This contains the materials needed by one of a pair of students, or members of a group, to enable them to carry out the communication activities in the **Task** sections.

### Audio script

This is a complete transcript of all the listening material in the Course Book. This can be used in different ways according to the levels and needs of your students. Students can use it to check their answers after they have completed a listening task.

### Review Units

Each Review Unit revises and practises material from the preceding two core units. In addition it contains a Project section, which gives the students opportunities to do some simple further research into topics linked to the topics of the core units. They are encouraged to use the internet or a library to carry out the research and present the results to the class either individually or as group tasks.

### Other student components

#### Workbook

The Workbook provides additional material based on the Course Book, which can be set as class revision or homework. It also contains a unit-by-unit word list.

The word list contains a list of key words used in the Course Book. Following each word list, there are 1–2 exercises which revise and practise use of these key words.

#### Course eBook

The Course eBook gives the complete Course Book in digital format, with audio embedded at point of use.

#### Mobile App

The Mobile App gives easy access to the course audio.

## Teacher's Book 1

### Unit summary

The first page of each core unit in the Teacher's Book sets out the key objectives of the core unit of the Course Book.

### Briefing

Each core unit in the Teacher's Book has a briefing which gives background information about the technical topics in the core units, and highlights any features of the language which need special attention in the unit. The briefing also has a **Further reading online** section which suggests some search terms that should help teachers and students find more in-depth information about the topics online.

### Teaching notes

Every main unit of the Teacher's Book contains procedural notes for each activity in the unit, ideas for extra activities if appropriate, answer keys and audio scripts. Every Review Unit contains answer keys for the Review Units in the Course Book plus a photocopiable **Quick test** of the preceding two main units, to test lexis, grammar, functions, reading and writing.

### Word list

This is at the end of the Teacher's Book. It contains all the key words used in the Course Book. It is sorted into alphabetical order with references to the unit where each word appears. The word list in the Teacher's Book is the same word list that appears in the Workbook, but with the added information of where it is first used in the Course Book.

### Teacher's Portal

#### Presentation Tool Essentials

This is a digital version of the Coursebook with embedded audio at point of use, and a 'show answers' function.

#### Audio

All of the recordings for the listening exercises in the Course Book and the Workbook are available to play or download.

#### Test package

This contains entry and exit tests, progress tests and individual unit tests in both pdf and word formats, which can be downloaded and edited as required. This means tests can be customised for specific purposes and institutions.

David Bonamy

## Contents

### 1 Basics

#### Objectives

In this section, students will ...

- listen and complete a dialogue with the verb *be*
- practise a dialogue introducing themselves
- complete a form with personal details
- ask a partner for personal details
- listen to a set of simple instructions for students to follow
- match opposite verbs
- do a quiz to check basic vocabulary
- match names of tools, fixings and electrical parts to pictures

### 2 Letters and numbers

#### Objectives

In this section, students will ...

- listen and correct a business card
- listen and complete forms in a range of contexts with names spelt out
- dictate and spell out details from own business card
- arrange letters according to sounds
- have a spelling competition: spell out and check spellings for cities and countries
- match the situations in pictures with announcements
- listen and insert numbers in text
- play the *Fizz Buzz* game to practise counting up to 100
- match a range of units with their abbreviations
- listen and write numbers next to correct units of measurement: electrical, temperature, dimensions, speeds, weight, capacity, currency

### 3 Dates and times

#### Objectives

In this section, students will ...

- listen to sports results and write times in a chart
- classify ordinals
- say the names of the months of the year
- say the names of the days of the week
- read out airport codes
- say days of flights
- listen and write down dates, using the written format
- dictate dates important to them to a partner using the spoken format
- complete a table with 24-hour clock and 12-hour clock times
- practise saying 12-hour/24-hour clock times
- add times to a flight timetable
- listen and write the correct time for watches
- practise saying combined times and dates
- practise having conversations using different times and dates

## Briefing

This unit looks at ways of greeting strangers and introducing oneself in a professional setting. It also provides a quick review of using letters, numbers, dates, times and units of measurement.

### 1 Basics

Section 1 practises language used in introducing oneself to others. Sofia, Jennifer, Danielle, Mr Rossi, Jamal and Borys are young technical professionals visiting a trade exhibition and meeting one another for the first time. Some different ways of introducing oneself, formal and informal, are practised. The use of contracted forms (such as *I'm* and *What's*) in more informal speech is highlighted. The question *What do you do?* (4) is used to ask someone what their job or profession is. The **adapter** shown in item 11 connects an electrical device to the **mains power supply**. (See Briefing for Unit 3.) The type of saw illustrated (item 4) is a **hacksaw** and cuts metal, as opposed to a **jack saw**, or **wood saw**, which cuts wood. The criss-cross **head** on the **screws** (item 5) is a **Phillips** head (see Briefing for Unit 2). The **spanner** (item 3) can also be called a **wrench**, especially in American English. (See the section on American and British English on page 110.) Your students need to be warned about the silent *w* in *wrench*.

### 2 Letters and numbers

Section 2 deals with letters and numbers, and how to spell out names, addresses, email addresses, phone numbers, product numbers and other items. **Nominal** numbers (used to identify things) and **cardinal** numbers (used to quantify or count things) are included. Nominal numbers, such as flight numbers, phone numbers, room numbers, **serial numbers**, **product numbers** and similar items, are said as separate digits: the phone number 0207 648 2317 is said as *oh-two-oh-seven-six-four-eight*, and so on, not *six hundred and forty-eight*, for example. As a number, 0 is pronounced *oh* or *zero*. The decimal point is said as **point**: 2.07 is said *two point oh seven*. Times are said as cardinal numbers, for example, *10.45* is *ten fortyfive*. Some units of measurement and their abbreviations such as *kilometre (km)* are practised with quantities in Exercises 9 and 10. Here numbers are expressed as cardinal numbers, because they signify quantities: *190 km/h* is said as *one hundred and ninety kilometres per hour*. See the *Reference* section on page 106 for more information on units and abbreviations.

### 3 Dates and times

Section 3 deals with ordinal numbers from 1 to 31 as an introduction to dates. Ways of writing and saying dates are practised. The different methods of writing dates (US *mm/dd/yy*; European *dd/mm/yy*; and so on) mentioned on page 9 can often lead to misunderstandings. The **ISO 8601 format** for dates and times (see the note on page 9) is an international system for specifying dates and times which is intended to eliminate this misunderstanding: the information is ordered from largest unit (the year) to the smallest (the second). The 24-hour clock and the 12-hour clock are practised here. The abbreviations *am* and *pm* are not used when the 24-hour clock is used. (Note that the phrases *o'clock*, *twenty past*, *quarter to* and so on are not specifically taught in this book, as the 12/24 hour clock systems are widely used; as an option, you could introduce or revise this method of telling the time as required.) In 6, the system for specifying days is used by airlines in their reservations system: *1* is Monday, *2* is Tuesday, etc. If a flight goes every Wednesday and Friday, this is written as *35 (three five)*.

#### Further reading online

Enter this search suggestion to find out more about the topic below:

**dates and times:** *iso 8601 date time format*





## Teacher's notes

### 1 Basics

This first lesson aims to help you to find out the level of your students' English. It checks some basic structures and vocabulary.

#### Start here

#### 1 1.1

Introduce yourself to a few students. Shake their hands and say who you are and where you're from. Take a few minutes doing this. Allow them to say as much or as little as they want to help you to judge at what pace to set this lesson.

Ask students to look at the picture. Ask them a couple of questions: *Who are the women?* (They're businesswomen.) *Where are they?* (They're at a conference.) Tell them that the women are introducing themselves to each other.

Ask them to look at the dialogue and the words in the box. Explain that you're going to play the recording of the conversation and they have to complete the gaps in the dialogue with the words in the box. Play the recording for students to complete the dialogues. Then choose three pairs of students to read out the completed dialogues.

Refer students to the box in the margin which shows examples of the contracted form of *be* used in the dialogues. Explain that when you speak English, it's more common to use the contracted form and encourage them to use contractions when speaking in class. Tell students that they'll find more information about the verb *be* in the *Grammar summary* on page 100.

1 am 2 is 3 Are 4 I'm 5 name's 6 I'm 7 Are 8 I'm

#### 1.1

- 1 **A:** Hello. I am Sofia Lopez.  
**B:** Hi. My name is Jennifer Conde.  
**A:** Pleased to meet you.
- 2 **A:** Excuse me. Are you Mr Rossi?  
**B:** Yes, I am.  
**A:** Pleased to meet you, Mr Rossi. I'm Danielle Martin.  
**B:** Nice to meet you, Danielle.
- 3 **A:** Hi. My name's Jamal.  
**B:** Hello, Jamal. I'm Borys.  
**A:** Good to meet you, Borys. Are you from Russia?  
**B:** No, I'm from Poland.

- 2 Put students in pairs. Demonstrate the activity with a confident student. Read out the first line, replacing the name Sofia Lopez with your own name and prompt the student to reply. Then say *Pleased to meet you* and shake the student's hand. Students then practise the dialogue in 1, changing the names and countries so that the information is about themselves.

## Writing

- 3 Explain the difference between block capitals and lower case. Write your name up on the board and the name of your country. Circle the first letter of your first name and your surname, and the name of your country and explain that normally you write the first letter of names and countries using capital letters, but not the other letters. Explain that in this activity they have to complete a form, using block capitals, i.e. all the letters are capitals. This makes the form easy to read. Show them what to do, by writing the form up on the board and completing it using information about yourself, in block capitals. They then complete the form about themselves.

#### Extra activity

Pre-teach some vocabulary for jobs that your students do to begin with. Brainstorm a list of jobs they do on the board. Keep the list up on the board for reference and for 4.

## Speaking

- 4 Ask a couple of students: *What do you do?* and elicit, e.g. *I'm a student, I'm an electrician, I'm a technician, etc.* Refer students to the note in the margin and explain that *What do you do?* is the same as *What's your job?* Explain that you use *a* before a consonant sound, e.g. *student, technician, builder, etc.* and *an* before a vowel sound, e.g. *electrician, architect, etc.*

Put students in pairs. They take it in turns to ask and answer the questions. Alternatively, students could mingle. Get them to walk around the class and ask and answer the questions with the other students.

#### Extra activity

Get students to write *a* or *an* in front of the jobs on the board.

## Listening

### 5 1.2

This activity practises instructions, using imperative forms. It also checks some basic verbs the class may or may not know. Tell students that they're going to play a game. Demonstrate the game with the class first before you play the recording. Explain that you will give some instructions and that they must follow the instructions only when you say *please* in the sentence. Tell them not to follow the instructions when you don't say *please* in the sentence. If they make a mistake, they're out of the game. When students understand what to do, play the recording.

### 1.2

OK, please follow these instructions.  
Please stand up.  
Sit down, please.  
Stand up again.  
Please stand up again.  
Raise your left arm.  
Please raise your left arm.  
Lower your arm, please.  
Now raise your right arm.  
Please raise it.  
Now lower your arm, please.  
OK, sit down.  
Sit down!  
Sit down, please.  
Write your name, please.  
Now say your name.  
Please say your name.  
Say *Hello*.  
Say *Hello*, please.  
Please pick up a book.  
Please read it silently.  
Now read it aloud.  
Read it aloud, please.  
Stop!  
Stop!  
Please stop.  
Please be quiet.  
Please say *Goodbye*.

## Vocabulary

- 6 Go through the words in the boxes with students. Tell them that these words all come from the listening in 5. Go through the example with the class first to show them what to do. Students match a word from the first box with its opposite in the second box.

pick up ≠ put down  
raise ≠ lower  
read ≠ write  
say ≠ listen  
stand ≠ sit  
start ≠ stop

### Extra activity

Students work in pairs. One student mimes one of the actions from 6 and another student guesses the word. Do an example for the class to guess first so that they know what to do.

- 7 This quiz checks students' knowledge of some basic vocabulary. Students look at the pictures and choose the correct option to complete the sentences about them.

1 a 2 b 3 a 4 a 5 b 6 a

- 8 This is another activity to check students' knowledge of vocabulary for tools, fixings and electronic parts. Ask students to look at the pictures and then match them with the words in the box. They can check their answers with a partner before you check with the class. Point out the plural words in this list are all regular plurals and that you simply add an s to the singular noun.

1 chisel 2 screwdriver 3 spanner 4 saw 5 screws  
6 nuts 7 bolts 8 washers 9 antenna 10 cable  
11 adapter 12 plug

### Extra activity

Put students into small groups. Students close their books. Ask one student to open their book and choose one of the objects from 8. Tell them they must not show their object to the other students. They then start to draw the object. The other students must try and guess what the object is. The first student to guess correctly gets a point and chooses another object to draw, and so on. Stop the game after ten minutes and find out who has the most points.

## 2 Letters and numbers

### Start here

#### 1 1.3

Ask students to look at the business card at the top of page 6. Explain that they're going to listen to Bruno Martyn introducing himself on the recording and that there are four mistakes on his business card. Play the recording once. Then play it again pausing it after he says his name, his telephone number and his email address to allow students to correct the information. They can then compare their answers with a partner.

Bruno Martyn  
Software Technician  
Tel: (0033) (0)5 62 19 85 64  
Email: mart17@macrosoft.co.fr

#### 1.3

I'm Bruno Martyn. That's M-A-R-T-Y-N. My phone number is oh oh three three, oh five, six two, one nine, eight five, six four. My email address is mart seventeen at macrosoft dot co dot fr, that's M-A-R-T seventeen at macrosoft dot co dot fr.

### Listening

#### 2 1.4

Ask students to look at the three forms. Explain the difference between first name, surname and full name. Write your own name on the board as an example. Tell students that most British and American names form this pattern: first name (+ middle name/names) + surname, e.g. *John Richard Wilson*. You can call him either *John* (informal) or *Mr Wilson* (formal). Tell them that *family name* is the same as *surname*.

Play the recording. Pause after each one for students to complete the forms.

|   |   |
|---|---|
| <p><b>1</b> QUAYLE<br/>VOX<br/>pq99@biz.com</p> <p><b>2</b> FIRE<br/>17 EAST STREET<br/>CS4 8NT<br/>MATHERS</p> | <p><b>3</b> PIETER BRAUN<br/>20953<br/>67<br/>GJ 8041</p> |
|---|---|

#### 1.4

**1** [R = Receptionist; Q = Mr Quayle]  
**R:** Welcome, sir. Could you give me your surname, please?  
**Q:** Yes, it's Quayle. Q-U-A-Y-L-E.  
**R:** And your company name, sir?  
**Q:** It's Vox.  
**R:** How do you spell that?  
**Q:** V-O-X.  
**R:** Thank you. And your email address, sir?  
**Q:** It's pq99 at biz dot com. That's P-Q-ninety-nine at biz dot com. That's B-I-Z dot com.

#### 2 [PO = Phone Operator; M = Ms Mathers]

**PO:** Emergency, which service?  
**M:** Fire.  
**PO:** Right, what's your address?  
**M:** 17 East Street.  
**PO:** Repeat the address, please.  
**M:** 17 East Street.  
**PO:** How do you spell East?  
**M:** E-A-S-T.  
**PO:** What's your postcode?  
**M:** CS4 8NT.  
**PO:** Repeat your postcode, please.  
**M:** CS4 8NT.  
**PO:** And your surname, please.  
**M:** Mathers.  
**PO:** How do you spell that?  
**M:** M-A-T-H-E-R-S.  
**PO:** Thank you.

#### 3 [CS = Customer Services; PB = Pieter Braun]

**CS:** This is Customer Services. How can I help you?  
**PB:** My wireless router doesn't work.  
**CS:** Oh, I'm sorry to hear that, sir. All right, please give me some details. What's your full name?  
**PB:** Pieter Braun.  
**CS:** How do you spell your surname?  
**PB:** B-R-A-U-N.  
**CS:** Thank you, Mr Braun. And what's your postcode?  
**PB:** 20953.  
**CS:** Thank you, and your house number, please?  
**PB:** 67.  
**CS:** Thank you, sir. And what's the number on the back of the router?  
**PB:** GJ 8041.  
**CS:** Could you repeat that, please?  
**PB:** GJ 8041.  
**CS:** Thank you.

### Speaking

- 3** For those students who don't have a business card, you can ask them to design their own card following the model in 1.  
Students can work with a partner or move round the class, spelling out the details from the business card.
- 4** Focus students' attention on the first column. Explain that *three* has the same sound /i:/ as in the letter *B*. Ask students to repeat headings and letters after you. Point out that two of the letters of the alphabet don't have the same vowel sounds in the headings and go in the EXCEPTIONS column. Students work on their own and put the letters in the correct column. They can then compare their answers with a partner. Finally, ask students to read out the letters in class to check that they're pronouncing the letters correctly.

| three | eight | five | ten   | two   | EXCEPTIONS |
|-------|-------|------|-------|-------|------------|
| B C D | A H   | I Y  | F L M | Q U W | O R        |
| E G P | J K   |      | N S   |       |            |
| T V   |       |      | X Z*  |       |            |

\*In American English, 'Z' is pronounced 'zee' and goes into column 1.

- 5 Put the class in small groups, and divide the groups into Teams A and B. Go through the instructions and the example with the class. Tell them to use their dictionaries to help them. Go round the class monitoring and helping students.

## Listening

### 6 1.5

Tell students to look at the pictures and ask them what they can see. Play the recording. Students listen to the announcements and match them with the pictures. Then ask individual students to read out the numbers for the answers.

1 E 2 B 3 A 4 D 5 C 6 F

### 1.5

- 1 Counter number 11, please.
- 2 This is Radio 1 on 98.8 FM.
- 3 Please pay 18 pounds and 80 pence.
- 4 The 14:43 train to Oxford will depart from platform number 9.
- 5 Flight number EZ 370 is boarding now. Please go to gate number 14.
- 6 Begin countdown now: 20, 19, 18, 17, 16, 15, 14, 13 ...

- 7 Play the recording again for students to complete the sentences with numbers and letters.

Note that for flight numbers you say *three seven oh*, not *three hundred and seventy*. Also note that you say *oh* for 0 in telephone numbers in British English. In American English, you say *zero*.

1 11 2 1; 98.8 3 18; 80 4 14:43; 9 5 EZ 370; 14 6 20, 19, 18, 17, 16, 15, 14, 13

### Extra activity

Write the number *nineteen* on the board, underlining the second syllable *teen*. Tell students that you put the stress on *teen* when you say the numbers 13 to 19 on their own. Play item 6 in the recording again and ask students to repeat the numbers. You could then ask them to continue counting down to one (or *Blast off!*).

## Speaking

- 8 Tell students that they're going to play a game with numbers. Go through the instructions and the example with the class. Ask students to close their books and organise the class so that they know when it's their turn to say a number. Demonstrate the game with the first five students by continuing counting quickly from 1 to 5, and make sure that they say *fizz* for three and *buzz* for five. Then ask students to start counting again from 1.

## Vocabulary

- 9 Students could work in small groups and discuss the meanings of these symbols.

Students probably won't have too much difficulty with this activity, as many of the abbreviations will be the same as in their own language. However, they may not be so familiar with the imperial measurements *inch*, *feet* and *gallon*, which are still used in the UK and the US.

|                              |                            |
|------------------------------|----------------------------|
| km = kilometre               | C = Celsius/centigrade     |
| + = plus                     | km/h = kilometres per hour |
| g = gram                     | m = metre                  |
| in = inch                    | £ = pound sterling         |
| kW = kilowatt                | - = minus                  |
| kg = kilogram                | ft = feet                  |
| L = litre                    | € = euro                   |
| V = volt                     | W = watt                   |
| A = amp                      | gal = gallon               |
| ° = degree                   |                            |
| rpm = revolutions per minute |                            |

## Listening

### 10 1.6

Play the recording for students to write the numbers by the correct symbol. Then play the recording again for students to repeat. Point out that *kilometre* is often pronounced *kilometre*, but can also be pronounced *kilometre*. Also note that in British English you write *kilometre* and *metre*, but in American English you write *kilometer* and *meter*.

Explain that, in English, for decimal numbers, you use a full stop not a comma and say *point*, e.g. for 1.2 km, you say *one point two kilometres*. You use commas for thousands, e.g. *150,000*. This may be different from their own language.

Finally, point out that you say numbers before currency, e.g. *18 pounds*, *80 euros*, but you write the symbol before the number, e.g. *£18*, *€80*.

1 89°C 2 13 A 3 1.2 km 4 13.8 m 5 15° 6 190 km/h  
7 12,500 rpm 8 160 kg 9 40 W 10 230 V 11 €80  
12 150,000 L

### 1.6

eighty euros  
fifteen degrees  
thirteen amps  
eighty-nine degrees Celsius  
forty watts  
one point two kilometres  
thirteen point eight metres  
one hundred and ninety kilometres per hour  
one hundred and fifty thousand litres  
twelve thousand five hundred revolutions per minute  
two hundred and thirty volts  
one hundred and sixty kilograms

### 3 Dates and times

#### Start here

#### 1 1.7

Ask students to look at the photo. Ask them if they know who the runner is and what the race is. Tell them to look at the form where they will find the information and check their answer. (The photo is of Joshua Cheptegei of Uganda winning the Men's 5000 metre race at the Tokyo Olympics 2020.)

Focus students' attention on the column with the heading *Position*. Remind them that in the last lesson they practised cardinal numbers (*one, two, three*, etc.) and that the numbers here are ordinal numbers (*first, second, third*, etc.). They show the order in which things come. Point out that some of the information in the last column for the athlete's time is missing. Play the recording for students to complete the missing information.

Allow students to compare their answers in pairs before you check with the class. Remind students that for decimal numbers you say *point* and explain that you say the numbers individually after the point, i.e. for *34.18*, you say *thirty-four point one eight*. Play the recording again and ask students to repeat the times.

**2nd** 58 **4th** 59, 17 **6th** 13, 03, 20

#### 1.7

Here are the results of the finals of the men's five thousand metre race:

In first place, it's Joshua Cheptegei from Uganda. His time is twelve minutes, fifty-eight point one five seconds.

In second place, it's Mohammed Ahmed from Canada. His time is twelve minutes, fifty-eight point six one seconds.

In third place, it's Paul Chelimo from the USA. His time is twelve minutes, fifty-nine point oh five.

In fourth place, it's Kimeli from Kenya. His time is twelve minutes, fifty-nine point one seven.

In fifth place, it's Kiplimo from Uganda. His time is thirteen minutes, two point four oh.

In sixth place, it's Balew from Bahrain. His time is thirteen minutes, three point two zero.

#### Speaking

- 2 Refer students back to the ordinal numbers used for the positions in the form in 1. Students put the ordinal numbers in the correct columns in the chart. They will notice that most of the numbers end in *th*, with the exception of *first, second* and *third*, and numbers that include *one, two* and *three* above *twenty*.

Students read the numbers out loud as a class. Make sure that they are pronouncing *fourth* and *fifth* correctly. Ask them to bite their bottom lip and blow some air out to pronounce /f/, then push their tongue up to touch their upper teeth to pronounce the /θ/ sound.

| <b>-st</b>            | <b>-nd</b>   | <b>-rd</b>   | <b>-th</b>  |
|-----------------------|--------------|--------------|---|
| 1st,<br>21st,<br>31st | 2nd,<br>22nd | 3rd,<br>23rd | 4th, 5th, 6th, 7th, 8th, 9th, 10th,<br>11th, 12th, 13th, 14th, 15th, 16th,<br>17th, 18th, 19th, 20th, 24th, 25th,<br>26th, 27th, 28th, 29th, 30th |

- 3 Go round the class, getting students to say the months of the year. Make sure that they have got the correct stress on *January, February, August, September, October, November* and *December*. Write these months up on the board with the stressed syllables underlined and get students to repeat them after you.

January, February, March, April, May, June, July, August, September, October, November, December

- 4 Go round the class, getting students to say the days of the week. Make sure that they aren't pronouncing the *d* in *Wednesday*. Also that they're pronouncing *Tuesday* with a /t/ sound at the beginning and a /θ/ sound for *Thursday*.

Monday, Tuesday, Wednesday, Thursday, Friday, Saturday, Sunday

- 5 In this activity, students revise the alphabet using airport codes. Ask students to look at the table of airport codes and read them out.

- 6 Ask students to look at the timetable of flights and focus on the column for days. (They will complete the columns for the departure and arrival times in the Listening in 11.) Point out that the numbers refer to days of the week and these are shown at the bottom of the form. Give them an example by asking what day is number 5.

Refer students to the information in the margin. Explain that for numbers, you write *306 people*, and you say *three hundred and six people*. However, for flights, rooms, ID, product numbers, etc. you use single digits. For example, *LH 306*, you say *LH three oh six* (or *three zero six* in American English). Students can then work with a partner and give the days of the week for each flight.

- LH 306 departs from Frankfurt on Mondays and Thursdays.
- AF 835 departs from Paris on Tuesdays, Thursdays and Saturdays.
- EK 971 departs from London on Mondays, Tuesdays, Thursdays and Fridays.
- MS 740 departs from Dubai on Mondays, Wednesdays, Fridays and Sundays.
- AZ 7788 departs from Rome on Tuesdays, Wednesdays, Fridays and Saturdays.
- SA 104 departs from Johannesburg on Mondays, Thursdays and Sundays.

## Listening

### 7 1.8

Refer students to the note about the different ways of writing dates and go through the information with them. Ask them for today's date, using *dd/mm/yy* and write it on the board.

Play the recording for students to write down the dates. They can then compare their answers with a partner before you check with the class. Tell them that for dates 2001 up to 2009 you say *two thousand and one, two thousand and two*, etc., but for dates above 2010 you say *twenty-ten, twenty-eleven, twenty-twelve*, etc.

- |              |              |
|--------------|--------------|
| 1 28/12/2025 | 3 21/07/1999 |
| 2 18/11/2019 | 4 12/01/2020 |

### 1.8

- 1 The 28th of December 2025.
- 2 The 18th of November 2019.
- 3 The 21st of July 1999.
- 4 The 12th of January 2020.

## Speaking

8 Demonstrate the activity by giving a date that is important for you. Say the date and write it up on the board, using *yy/mm/dd*. Students then dictate dates to their partner.

9 Ask students what the time is. Write it up on the board using the 12-hour clock and the 24-hour clock. Make sure they understand when they have to use *am* for morning and *pm* for afternoon, and that for *08:05*, you say *oh eight oh five*. Refer students to the note in the margin and remind them that in American English you say *zero* for *oh*.

Students complete the table. Go round the class checking their work while they're doing this. Then ask individual students to read out their answers.

- |           |           |           |           |         |
|-----------|-----------|-----------|-----------|---------|
| 1 7.50 am | 2 06:30   | 3 3.15 pm | 4 2.40 pm | 5 16:45 |
| 6 13:35   | 7 8.25 pm | 8 5.55 am | 9 21:10   |         |

10 Students read out the times using the 24-hour clock then the 12-hour clock.

- 1 five fifteen, five fifteen am
- 2 eight fifty, eight fifty am
- 3 eleven fourteen, eleven fourteen am
- 4 thirteen forty, one forty pm
- 5 fifteen eighteen, three eighteen pm
- 6 seventeen thirty, five thirty pm

## Listening

### 1.9

11 Ask students to look back at the timetable of flights in 6 on page 8. Play the recording for students to add the times to the timetable. Note that the 24-hour clock is normally just used for travel times in Britain.

- 1 Depart: 07:30, Arrive: 09:05
- 2 Depart: 08:20, Arrive: 10:10
- 3 Depart: 06:30, Arrive: 15:15
- 4 Depart: 14:40, Arrive: 17:50
- 5 Depart: 21:10, Arrive: 16:15
- 6 Depart: 15:45, Arrive: 21:25

### 1.9

- 1 LH 306 departs from Frankfurt at seven thirty am and arrives in Warsaw at nine oh five am.
- 2 AF 835 departs from Paris at eight twenty am and arrives in Madrid at ten ten am.
- 3 EK 971 departs from London at six thirty am and arrives in Bahrain at three fifteen pm.
- 4 MS 740 departs from Dubai at two forty pm and arrives in Cairo at five fifty pm.
- 5 AZ 7788 departs from Rome at nine ten pm and arrives in Tokyo at four fifteen pm the next day.
- 6 SA 104 departs from Johannesburg at three forty-five pm and arrives in Lagos at nine twenty-five pm.

### 12 1.10

Ask students to look at the four watches. Ask students to tell their partner what the times are using the 24-hour clock. Then play the recording for students to label the watches in the order of the times that they hear.

- 1 D 2 A 3 C 4 B

### 1.10

- 1 It's eighteen thirty-five on the fifteenth of September.
- 2 It's eight fifty-five on the fifth of November.
- 3 It's thirteen forty-five on the thirteenth of December.
- 4 It's fourteen fifty-five on the thirtieth of October.

13 Students read out the times and dates on the watches in 12, using the 12-hour clock.

- A It's eight fifty-five am, on the fifth of November.
- B It's two fifty-five pm, on the thirtieth of October.
- C It's thirteen forty-five on the thirteenth of December.
- D It's six thirty-five pm, on the fifteenth of September.

## Social English

14 Ask students to look at the information on the note. Demonstrate the activity by asking one student to take the part of B and read out the conversation with them. Then ask students to take it in turns to practise the conversation, using different days and times.



## Contents

### 1 Naming

#### Objectives

In this section, students will ...

- listen to skateboarding records (dimensions, dates) and complete a table
- label the parts of a skateboard on a diagram
- listen to check labelling
- listen and complete a dialogue
- practise the dialogue using all the parts on the diagram
- study language for asking what something is called and saying it
- complete four dialogues
- listen and repeat words for fixings
- match words with pictures of fixings
- practise asking and answering questions about fixings
- practise asking about things that are near and far
- identify vehicles from unusual photos and practise asking and answering the questions about them

### 2 Assembling

#### Objectives

In this section, students will ...

- choose items they need to assemble a skateboard
- listen and complete a checklist with sizes and quantities
- practise dialogues in pairs explaining what is needed
- put diagrams of stages of assembly into the correct order to prepare for the reading
- read an instruction manual and check diagrams are in the correct order
- practise word order and parts of speech by completing a table with *verb + object + location*
- listen and repeat verbs
- complete instructions with opposite verbs
- complete a table with opposite verbs

### 3 Ordering

#### Objectives

In this section, students will ...

- listen to and note down a voicemail message
- listen and correct spellings and numbers
- dictate words from the unit and spell them out for a partner to write
- leave phone messages by spelling out name, company and numbers for their partner to note and then check against cards
- practise making phone calls to order a skateboard using details from an internet site
- listen to an introduction, then introduce themselves and a friend



## Briefing

This unit looks at ways of communicating about the parts (or components) of a tool or device, including using an instruction manual.

### 1 Naming

Section 1 deals with identifying and naming the parts of a skateboard. In fact, the names of parts introduced here are not limited to skateboards, but can be found in a range of technical devices and machines. A **plate** is a strong, flat piece of metal, often used for fixing one thing to another. It often has holes in it for screws or bolts. In this case, the plate is used for attaching the wheel assembly to the deck of the skateboard. In general, a **deck** is a flat structure, used as a platform for supporting something or someone, as in the deck of a boat or ship. The deck of the skateboard is the flat piece of wood or strong plastic which the skateboarder stands on. The **nose** of a vehicle or craft (such as a rocket, plane or skateboard) is the front part; the **tail** of a plane or skateboard is the **rear** or back section. A **wheel** rotates around a strong metal rod called an **axle**. The **truck** of a skateboard is another word for the **wheel assembly**. An **assembly** means a group of parts assembled to form a single unit: if you assemble the wheel, axle and plate, you create the truck. The word *truck* (or **lorry**) has another meaning: a large road vehicle for carrying goods.

The fixings in Section 1 are found in a range of technical fields. **Nails** are sharp and made of metal; they are hammered into wood. **Screws** are pointed and have a **thread**; they have to be rotated under pressure with a **screwdriver** into wood or masonry. **Bolts, nuts** and **washers** go together: they are used to fasten wood, plastic or metal parts together. Bolts have a thread but are not pointed; you place a nut and a washer on the end of the bolt and then tighten the nut or the bolt with a **spanner**. **Staples** are commonly used for holding telephone wires or cables close to a wall.

The language box at the top of page 11 explains the difference between *What's this called?* (when you know what something is, but don't know the technical term or English word for it) and *What's this?* (when you don't know what the thing is, in any language).

### 2 Assembling

Section 2 introduces the sizes of fixings. In Europe, fixings are sized in **millimetres** (abbreviation **mm**). The UK and the US use both millimetres and *inches* (one inch is approximately 2.4 cm). Although the plural *millimetres* is used in speech, the written abbreviation *mm* never adds an *-s*. The colloquial word *mil* is used for singular and plural (*one mil*; *five mil*). The capital letter *M* before a number refers to the diameter or thickness of a screw or bolt: *M6* means *6 mm in diameter*.

3 has been kept simple. In reality, customers would probably specify both the length and the width of the bolts, screws or nails: *What size? 10 mm (or M10) by 65 mm, please.* (Note the use of **by** when you give two or more dimensions.) They would also probably specify the type of screw/screwdriver **head**, for example **slotted**, **Phillips** or **Posidrive** (or **Pozidriv**). If your students are in trades such as building and construction, you could ask them to add details such as these.

The verb **assemble** (transitive) has two common synonyms which are transitive phrasal verbs: **put together** and **fit together**. For example, *assemble the skateboard = put the skateboard together*. (The word order of phrasal verbs with noun/pronoun objects is taught in Book 2.) Notice in 8 that to **tighten** a nut or bolt you normally rotate it in the direction of a clock's hands (or **clockwise**) as you look at it; to **loosen** it you normally rotate it **anti-clockwise**.

### 3 Ordering

Section 3 looks at how to order items.

#### Further reading online

Enter these search suggestions to find out more about the topics below:

**skateboards:** *ehow set skateboard*

**fixings:** *screws screwdrivers bolts sizes*

**hand tools:** *hand tool type spanner wrench*



## Teacher's notes

### 1 Naming

#### Start here

#### 1 2.1

Ask students to look at the photo of the skateboarder and ask the class: *Is the skateboarder doing a high jump or a long jump? (High jump.)* Then tell students to look at the table and ask if any of them know or can guess the records for the skateboarding high jump and long jump. Play the recording for students to complete the form.

When checking the answers, remind students that you use a full stop to show decimals and not a comma, and that you *say point*, e.g. *7.1 (seven point one) metres*. Explain that they should use the European system to write the dates in the table. Students then compare their answers before you check with the class.

1 7.77 metres, 18/07/2015

2 24 metres, 08/08/2004

#### 2.1

The world record for a high jump on a skateboard is 7.77 metres. A skateboarder, Danny Way, jumped 7.77 metres on the 18th of July 2015.

The world record for a long jump on a skateboard is 24 metres. Skateboarder Danny Way jumped 24 metres on the 8th of August 2004.

### Vocabulary

- 2 Put students in pairs. Ask them to look at the diagrams of the skateboard and label them with the words in the box. Do not confirm answers as this will be done in 3.

### Listening

#### 3 2.2

Play the recording for students to check their answers to 2. Then check their answers, making sure that they're pronouncing all the words correctly.

1 tail 2 truck 3 deck 4 nose 5 wheel 6 axle  
7 plate

#### 2.2

1 tail  
2 truck  
3 deck  
4 nose  
5 wheel  
6 axle  
7 plate

#### 4 2.3

Point to a part of the skateboard and ask *What's this called?* and elicit the answer. Then ask students to look at the dialogue. Play the recording for students to complete the dialogue.

Explain that you use *this* when you talk about something that is near to you. Then ask one half of the class to read out the questions in the dialogue, pointing to the parts they're asking about, and ask the rest of the class to answer the questions. Make sure that students are using the contractions. *What's* in the question and *It's* in the answer.

1 called 2 called 3 this 4 a

#### 2.3

A: What's this called?

B: It's called a deck.

A: What's this called in English?

B: It's called a truck.

### Speaking

- 5 Go through the example with the class first and the two options for the question. Then put students in pairs to practise the dialogue, asking and answering questions about all the other parts of the skateboard. Remind them to point to the part on the diagram when asking the question.

## Language

### What's this? What's this called?

Go through the language box with the students. Explain that you say *What's this?* when you don't know what something is (even in your own language), and you say *What's this called?* when you know what the object is, but you don't know the word for it in another language.

Remind students that you use *this* to talk about something that's near you. Then tell them that when something is far away, you use *that*. For plural objects that are near you, you say *these* and for plural objects that are far away, you say *those*.

Demonstrate *this*, *that*, *these* and *those* using objects that you have with you or that are in the classroom.

- 6 Ask students to look at the pictures and complete the dialogues with the words in the box.

Ask students to read out the answers. Check that they're pronouncing /ð/ correctly. Show them that the end of the tongue must be past their teeth. Tell them that in English you can pronounce *th* two different ways. Remind them of the pronunciation of ordinal numbers *fourth*, *fifth*, *sixth*, etc., which has an unvoiced sound /θ/. The sound /ð/ in *this*, *that*, *these* and *those* is voiced. Tell them to touch their throats as they say the words and they should feel their throat vibrating. Check also that they're differentiating between the short /ɪ/ sound in *this*, and the longer /i:/ sound in *these*.

- |              |                  |
|--------------|------------------|
| 1 this, It's | 3 these, They're |
| 2 that, It's | 4 those, They're |

## Vocabulary

7  2.4

Play the recording for students to listen and repeat the words. Make sure that they're pronouncing the words correctly.

 2.4

nails  
bolts  
nuts  
spanner  
washers  
staples  
screws  
screwdriver

- 8 This exercise revises many of the words from the vocabulary in 8 from Unit 1, Lesson 1. Ask students to look at the pictures and match them with the words from 7. Do not confirm answers at this stage.

- |           |           |               |         |           |
|-----------|-----------|---------------|---------|-----------|
| 1 screws  | 2 nuts    | 3 bolts       | 4 nails | 5 washers |
| 6 staples | 7 spanner | 8 screwdriver |         |           |

## Speaking

- 9 Put students in pairs. Students now check their answers to 8 with their partner. Tell students to point to the picture when asking the question.

Go round checking that they're pronouncing the words correctly and using contractions. Then check the answers with the whole class.

- 10 Students now point to objects inside or outside the classroom and ask the other students what they're called. Remind them to point clearly at the objects they want to find the English word for. If none of the students knows the answer, tell them to look in a bilingual dictionary or ask you. Remind them to use *this* and *these* for things that are near them and *that* and *those* for things that are far away.

- 11 Put students in small groups. Ask them to point to the pictures and ask each other what the vehicles are. When they've finished they can check their answers on page 113.

- |              |          |                 |         |
|--------------|----------|-----------------|---------|
| 1 racing car | 2 rocket | 3 mountain bike | 4 plane |
| 5 motorbike  | 6 boat   |                 |         |

## 2 Assembling

### Start here

- 1 First, check that students understand the title of this section by asking them to read the information in the box. Put students in pairs. Ask them to look back at the words from 7 on page 11, and discuss which items from the list they need to assemble a skateboard.

### Listening

#### 2 2.5

Ask students to look at the photo. Ask them what type of shop it is (a skateboard shop) and what sorts of things you can buy there. Then ask students to look at the checklist. Tell them that they're going to listen to a customer in the shop asking for the things in the checklist. Go through the information in the box in the margin first, then play the recording for students to complete the checklist.

- 1 spanner: 10 mm, 1
- 2 nuts: 7 mm, 4
- 3 bolts: M5, 8

#### 2.5

[C = Customer; S = Shopkeeper]

- C:** Hello.  
**S:** Good morning. What can I do for you?  
**C:** I need a spanner, please.  
**S:** What size do you need?  
**C:** Erm, I think it's ten millimetres.  
**S:** OK. Here you are. One ten-millimetre spanner.  
**C:** Thanks. And I need some nuts, please.  
**S:** Some nuts, did you say? OK, what size do you need?  
**C:** Erm ... seven mil.  
**S:** Right. And how many do you need?  
**C:** Four.  
**S:** Right. Here you are. Anything else?  
**C:** Yes, I need some bolts, please.  
**S:** What size?  
**C:** M5.  
**S:** And how many M5 bolts do you think you need?  
**C:** Eight, please.  
**S:** OK, here you are.  
**C:** Thanks.

#### Extra activity

Ask students to turn to Audio script 2.5 on page 120 and read the dialogue as you play the recording again. Then practise reading out the dialogue in pairs.

## Speaking

- 3 Tell students that they're going to practise asking for the things they need to assemble a skateboard in a shop. Tell them to look back at the checklist and ask them what questions the shopkeeper uses when he asks about the size and quantity of the things the customer needs. (*What size ...? How many?*)

Ask students to look at the example dialogue. Choose a confident student. Take the part of the shopkeeper and ask the student to be the customer and read the dialogue out.

Then put students in pairs to practise asking for things in a shop, using the items listed. Go round listening to their dialogues and check that they're putting the stress on the first syllable of *millimetre*.

### Task

- 4 Ask students to look at the diagrams and put them in the order in which you assemble a skateboard. Students could then compare their order with a partner. Do not confirm answers at this stage.

## Reading

- 5 Ask students to read the instruction manual and check their diagrams in 4 are correct according to the manual.

1 F 2 B 3 D 4 E 5 C 6 A

## Language

- 6 Ask students to look at the table and the examples. Explain how the sentences are divided up into verb, object and location. Then ask them to complete the table in the same way using the information in the instruction manual in 5. Point out that they need to leave some spaces in the location column blank.

|   |         |               |                    |
|---|---------|---------------|--------------------|
| 1 | Put     | the plate     | on the four bolts. |
| 2 | Put     | the nuts      | on the bolts.      |
| 3 | Tighten | the nuts.     |                    |
| 4 | Put     | the axle      | on the large bolt. |
| 5 | Put     | the large nut | on the large bolt. |
| 6 | Tighten | the nut.      |                    |
| 7 | Put     | the wheels    | on the axle.       |
| 8 | Put     | the nuts      | on the axle.       |
| 9 | Tighten | the nuts.     |                    |

## Vocabulary

- 7  2.6

Play the recording for students to listen and repeat the verbs. Make sure that they're pronouncing the words correctly, particularly the /ʊ/ sound in *push*, *pull* and *put*, and the /u:/ sound in *loosen*.

 2.6

loosen  
pull  
push  
put  
take  
tighten

- 8 Ask students to look at the pictures and complete the instructions below them using the words from 7. They can then compare their answers with a partner before you check with the class.

1 Put 2 Take 3 Push 4 Pull 5 Tighten 6 Loosen

- 9 Ask students to look at the verbs in the table and to write their opposites.

1 take (off) 2 loosen 3 pull

### Extra activity

Put students in pairs and ask them to look back at the pictures and sentences in 8. Ask them to give instructions in the same way to a partner to mime, e.g. *Put the book on the table.*

### 3 Ordering

#### Revision

Quickly revise numbers with the class. Think of an eight-digit telephone number, make a note of it and hide it from the students. Don't use one with repeated numbers such as 00 or 99. Stand next to a student and whisper the telephone number in their ear. They then whisper that number into the next student's ear, and so on, until the number is repeated round the whole class. Ask the final student in the class what the number is, and check it with the number you'd written down at the beginning of the game.

#### Listening

##### 1 2.7

Ask students to look at the notes about the voicemail message, and ask them what information is missing. Play the recording for students to complete the notes. Read the answer out to the class and ask students to repeat it.

Name: Ben Johnson  
Phone number: 0044 208 8947

##### 2.7

Thank you for calling Skateboards 4 U. Please leave a message after the tone.

Erm, Hello. Erm, I need some parts ... er ... for my skateboard. My name is Ben, Ben Johnson. That's J-O-H-N-S-O-N. My er ... my phone number is ... double oh, double 4, 208 8947. Please call me back. Thanks.

##### 2 2.8

Go through the notes in the margin. Remind students that when giving telephone numbers, you say *oh* in British English and *zero* in American English. Explain that you can say *five five* or *double five* when you repeat a number. Point out that phone numbers are usually read out in blocks of numbers with pauses between them, and that you say them as individual numbers, e.g. *double oh double four* [pause] *two oh eight* [pause] *eight nine four seven*.

Ask students to look at the names and numbers and explain that these names and numbers aren't correct. Tell them that they're going to listen to the correct names and numbers on the recording, and as they listen they should correct the mistakes. Play the recording. Pause after each one for students to make the corrections.

They can then check their answers with a partner before you play the recording one more time.

- 1 Abdul Monim Waheed 00 202 48830
- 2 Jose Fernando Ruiz 00 35 912 828 990
- 3 Adil Al-Mansur 00 971 2 605 9943
- 4 Nikolai Kuznetsev 00 7 455 988 22 77

##### 2.8

- 1 Abdul ... that's A-B-D-U-L Monim ... spelt M-O-N-I-M Waheed ... that's W-A-H-E-E-D, and my phone number is 00 202 48830.
- 2 Jose ... that's spelt J-O-S-E Fernando ... that's F-E-R-N-A-N-D-O Ruiz ... that's R-U-I-Z. Phone number 00 35 912 828 990.
- 3 Adil spelt A-D-I-L Al-Mansur ... that's A-L hyphen M-A-N-S-U-R. Phone number 00 971 2 605 9943.
- 4 Nikolai that's N-I-K-O-L-A-I Kuznetsev ... that's spelt K-U-Z-N-E-T-S-E-V. Phone number 00 7 455 988 2277.

#### Speaking

- 3 Put students in pairs. Tell them to choose words they've learned from Unit 2. Tell them they're going to dictate these words to their partner. Ask them to write down the words, making sure that the spelling is correct, but not to show the words to their partner. You could give them a maximum of six words each to dictate. They take it in turns to spell the word out for their partner to write down. They can then check their partner's spelling and then compare their answers to find out who has spelt the most words correctly.
- 4 Put students in pairs. Ask Student A to turn to page 112 and read the instructions. Student B leaves a message on Student A's voicemail, using the information from the business cards. They should spell out the names clearly. Tell Student A to say *Can you repeat that, please?* if they missed anything. Student A makes notes about their partner's business cards. They then swap roles. Finally, students can check the details in the notes their partner has made, making sure that their partner has spelt the names correctly and that the telephone numbers are correct.

## Task

- 5 Put students in pairs. Ask Student A to turn to page 112. Ask both students to look at the website advertisement and read their role. Tell them to look at the order form. Take the part of Student B and read the example dialogue with a confident student as Student A.

Remind students of the shop dialogue they practised on page 12 and elicit the questions the shopkeeper used to ask about size and quantity. Then refer students to the useful phrases box where they will find a list of questions that the salesperson will need to ask the customer. (Note that students will study present simple question forms in more detail in the next unit, so don't go into detail at this stage. Just teach these as phrases.) You could do the Extra activity below before they start their roleplay.

Students now take it in turns to order the items that are circled, with the student who is taking the part of the shopkeeper making a note of the items their partner orders. Student B starts the conversation by asking Student A for items circled in their list and Student A makes a note of what their partner has ordered. When they've finished ordering, ask Student A to check with their partner that they've taken down the correct information. They then swap roles.

Students then choose other items from the advertisement and take turns to phone up each other to order them, again making notes of the order and checking afterwards that they have the correct information.

### Extra activity

Ask students to match 1–6 below with the replies a–f.

- |                             |                     |
|-----------------------------|---------------------|
| 1 What size?                | a 064 3549          |
| 2 How many?                 | b blue              |
| 3 What's your name?         | c Carmen            |
| 4 Please spell that.        | d large             |
| 5 What's your phone number? | e two               |
| 6 What colour do you need?  | f F-E-R-N-A-N-D-E-Z |
- 1 d 2 e 3 c 4 f 5 a 6 b

## Social English

### 6 2.9

Ask students to look at the photo of the people introducing themselves to each other. Ask them to read the dialogue while you play the recording. Point out the contracted form *He's* and tell them that they should use *He's* or *She's* when speaking.

Then put students into groups of three. They practise introducing themselves and their partner to another student. When they've finished, you could ask groups of three to stand up, with one of the students introducing themselves and the other two students to the class.

### 2.9

**A:** I'm Luis. I'm a student. And this is Paulo. He's a student, too.

**B:** Hello, Luis. Hello, Paulo. Nice to meet you.

# Review Unit A

## Answer key

- 1** 1 Is the machine on?  
2 Are the switches off?  
3 Is Roberto in London?  
4 Are they IT technicians?  
5 Is he a student?  
6 Is she Polish?

- 2** 1 No, it isn't Sunday today. It's Monday.  
2 No, the power isn't on. It's off.  
3 No, I'm not Peter. I'm John.  
4 No, they aren't from Berlin. They're from Bonn.  
5 No, she isn't a technician. She's an engineer.  
6 No, he isn't an electrician. He's a builder.

- 3** 1 My name's Jamal and I'm from Jordan.  
2 This is Jean. He's French, but he isn't from Paris.  
3 This is Frieda. She's from Rome, but she isn't Italian.  
4 Look at the switch. It's down, but the power isn't on.  
5 These are the wrong items. They aren't bolts. They're screws.  
6 What's this tool called? What are these called?

- 4** 1 are 2 do 3 Are 4 does 5 is 6 Are  
a) is b) am c) is d) are e) am f) is

- 5** 1 e 2 b 3 a 4 f 5 c 6 d

- 8** 3 screws 6 nails  
8 bolts 5 nuts  
4 washers 1 staple  
1 spanner 1 screwdriver

- 9** on ≠ off left ≠ right  
stand ≠ sit up ≠ down  
large ≠ small open ≠ closed  
in ≠ out tighten ≠ loosen  
stop ≠ start

- 10** 1 b 2 a 3 b 4 b

- 11** PRACTISE YOUR ENGLISH EVERY DAY WITH A FRIEND

- 12** 1 What 2 How 3 What 4 What 5 What's 6 What's

- 13** 1 Monday, the tenth of April 2017 at 1.40 pm.  
2 Friday, the eighteenth of November 2022 at 7.55 am.  
3 Wednesday, the third of September 2025 at 11.05 am.  
4 Tuesday, the twenty-ninth of January 2030 at 9.32 pm.

- 14** a 11, 13, 17 (prime numbers)  
b 13, 21, 34 (Fibonacci numbers)  
c 37, 50, 65 ( $n^2 + 1$ )  
d 110, 111, 1000 (binary numbers)

- 15** 1 five kilometres  
2 two hundred and fifty kilograms  
3 one thousand and fifteen euros  
4 one hundred and ten volts  
5 nought degrees Celsius  
6 thirteen millimetres

- 16** 1 T 2 T 3 F 4 T 5 T 6 F 7 F 8 T 9 F 10 T 11 F 12 T

- 17** a Loosen b Use c Take d off e Take f off  
g Loosen h Use i Take j off k Take l off

- 18** 1 Tighten the screws.  
2 Use the large hammer.  
3 Take the old wheel off the car.  
4 Put the new wheel on the car.  
5 Hammer the nails into the wood.  
6 Push the bolts through the holes.



## Project

- 19 At the end of every Review Unit is a project. Students can do their research on the internet or in a library and in their own language if they wish. They must then write up their results in English.

## Quick test answer key

### Part 1: Vocabulary and grammar

- 1
- |            |             |         |
|------------|-------------|---------|
| 1 on       | 4 off       | 7 Start |
| 2 Read     | 5 open      |         |
| 3 Put down | 6 Listen to |         |
- 2
- |           |          |              |
|-----------|----------|--------------|
| 1 plate   | 2 wheel  | 3 skateboard |
| 4 antenna | 5 washer |              |
- 3
- One hundred and twenty kilometres per hour
  - Fifteen euros
  - The twenty-second of December two thousand and nine
  - Thirty-six degrees Celsius
  - Five minutes, thirty-two point eight oh seconds
  - Oh double five, three one oh, eight six three, two double seven
  - Fifteen point four five
  - One thousand, two hundred and eighty-three litres
- 4
- |          |         |          |
|----------|---------|----------|
| 1 Are    | 4 Is    | 7 Are    |
| 2 'm not | 5 isn't | 8 aren't |
| 3 'm     | 6 's    | 9 're    |
- 5
- Where's he from?
  - What do you do?
  - How do you spell *staple*?
  - What's this/that?
  - What are they called?
  - How many screws do you need?
  - What size do you need?
- 6
- I need some washers, please.
  - Put the wheels on the axle.
  - Take the hammer off the table.
  - The spanner is under the box.

## Part 2: Reading and writing

### Reading

1 F 2 F 3 T 4 T 5 F

### Writing

Time/Date of message: (1) 2.30 pm 5th March.  
First name: (2) Sue  
Surname: (3) Whittaker  
Company: (4) Bluesports  
Message: (5) Cancel order for 60 blue kneepads



# Review Unit A | Quick test

Total \_\_\_\_\_/50

## Part 1: Vocabulary and grammar

### 1 Complete the opposites.

- 1 It's under the table. It's \_\_ the table.
- 2 Write the email. \_\_\_\_\_ the email.
- 3 Pick up your pen. \_\_\_\_\_ your pen.
- 4 Turn on the TV. Turn \_\_\_ the TV.
- 5 The shop is closed. The shop is \_\_\_\_\_.
- 6 Say the numbers. \_\_\_\_\_ the numbers.
- 7 Stop the car. \_\_\_\_\_ the car.

(7 marks)

### 2 Underline the odd word out in each group.

- 1 adapter, cable, plate, plug
- 2 boat, bike, plane, rocket, wheel
- 3 axle, deck, nose, skateboard, tail
- 4 antenna, bolt, nut, screw, nail
- 5 chisel, saw, screwdriver, spanner, washer

(5 marks)

### 3 Write the numbers and abbreviations in words.

- 1 120 km/h \_\_\_\_\_
- 2 €15 \_\_\_\_\_
- 3 22/12/09 \_\_\_\_\_
- 4 36°C \_\_\_\_\_
- 5 Time: 5:32.80 \_\_\_\_\_
- 6 Phone: 055 310 863 277 \_\_\_\_\_
- 7 15.45 \_\_\_\_\_
- 8 1283 L \_\_\_\_\_

(8 marks)

### 4 Complete the dialogues with the correct form of the verb *be*. Use contractions where necessary.

**A:** (1) \_\_\_\_\_ you an engineer?

**B:** No, I (2) \_\_\_\_\_. I (3) \_\_\_\_\_ an IT consultant.

**A:** (4) \_\_\_\_\_ Patrizia from Germany?

**B:** No, she (5) \_\_\_\_\_. She (6) \_\_\_\_\_ from Switzerland.

**A:** (7) \_\_\_\_\_ they 10 mm nails?

**B:** No, they (8) \_\_\_\_\_. They (9) \_\_\_\_\_ 8 mm nails.

(9 marks)

### 5 Write questions for these answers. Use *What*, *Where*, *How*.

1 \_\_\_\_\_?

He's from Egypt.

2 \_\_\_\_\_?

I'm an electrician.

3 \_\_\_\_\_?

S-T-A-P-L-E

4 \_\_\_\_\_?

It's a tool.

5 \_\_\_\_\_?

They're called nuts.

6 \_\_\_\_\_ screws \_\_\_\_\_?

I need about 50.

7 \_\_\_\_\_?

10 mm, please.

(7 marks)

### 6 Put the words in the correct order to make sentences.

1 need / please / I / some washers

\_\_\_\_\_

2 the wheels / on the axle / put

\_\_\_\_\_

3 off the table / the hammer / take

\_\_\_\_\_

4 under the box / the spanner / is

\_\_\_\_\_

(4 marks)

## Part 2: Reading and writing

### Reading

Read the text. Are the sentences true (T) or false (F)?

#### How to change a wheel on a car

First, put your handbrake on. Then loosen the wheel nuts on the wheel. Use the spanner. (Sometimes the nuts are very tight.) Then raise the car off the road. Use the jack. Remove the wheel nuts and put them in a safe place. Take off the wheel, and then put on the new wheel and replace the wheel nuts. Tighten the nuts with your hand first. Then lower the car. Use the spanner and turn the nuts as tight as you can.

- 1 You loosen the nuts on the wheel first. **T/F**
- 2 When you change the wheel, the car is on the road. **T/F**
- 3 You put the old wheel nuts back on the car. **T/F**
- 4 You use your hand to tighten the nuts. **T/F**
- 5 The nuts aren't tight on the new wheel. **T/F**

(5 marks)

### Writing

Read the telephone message and complete the form with the details.

(5 marks)

Hi  
This is Sue Whittaker from Bluesports on the 5th March. It's two thirty in the afternoon. I'm phoning to cancel the order for 60 blue kneepads.

Time/Date of message: (1) \_\_\_\_\_

First name: (2) \_\_\_\_\_

Surname: (3) \_\_\_\_\_

Company: (4) \_\_\_\_\_

Message: (5) \_\_\_\_\_

## Contents

### 1 Tools

#### Objectives

In this section, students will ...

- listen and complete a TV advert with names of parts of the Multi Tool
- complete a dialogue with *have, do, does, doesn't*
- listen and repeat names of tools
- study the present simple of *have*: question and negative forms
- practise a dialogue with all forms of present simple of *have*
- design their own multi tool in pairs
- label another survival tool with names of parts
- read a product review of a survival tool and check answers
- practise asking and answering questions about the tools
- match parts of tools in pictures to their names – *handle, shaft, etc.*
- draw tools they use, label parts and describe them
- compare three products in a chart and make true sentences
- write a comparison of the three products from the product comparison table

### 2 Functions

#### Objectives

In this section, students will ...

- identify four sources of power to prepare for the reading
- label a diagram of an emergency radio
- listen and repeat names of parts of an emergency radio
- read a product description and check answers
- explain functions of parts of the radio from the reading text
- match radio parts with their function
- make sentences about the parts and functions
- study present simple questions, short answers and negative forms
- make questions and answers
- match verbs to pictures
- make sentences
- make a list of job titles useful for them
- ask questions to find out what other students in the class do

### 3 Locations

#### Objectives

In this section, students will ...

- listen to a computer lesson and complete a dialogue
- match a bank of monitors with their locations
- study prepositions of location
- read a description of a computer station setup and correct the mistakes according to a diagram
- study prepositional phrases that describe location
- study prepositional phrases and decide when it is appropriate to use them
- complete sentences about the computer station with prepositions
- make sentences about the location of the computer station
- practise a conversation telling someone in an electronics shop where things are

## Briefing

This unit looks at the parts and components of tools, their functions and locations.

### 1 Tools

Section 1 introduces the names of some common hand tools such as **hammer, knife, saw, spanner** and **ruler**. A **pick** is a sharp pointed tool. **Scissors** and **pliers** are always plural and are often used with **pair**: *a pair of pliers, a pair of scissors*. A **can opener** is a tool which opens tin cans; a **bottle opener** opens bottles. Section 1 also introduces names for *parts* of tools. Many tools (such as hammers and axes) have a **head**, which does the heavy work of the tool. Most tools (such as chisels and saws) have a **handle** which allows the user to hold it. Longer tools (such as spades) and sports equipment (such as tennis rackets) may also have a **shaft**: a long, straight bar of strong material. Sharp tools usually have a **blade**. The plural word **jaws** is used for two parts which move together like the jaws of an animal. Pliers, **pincers** and the **chuck** of a **drilling machine** have jaws. The verb *consists (of)* is used in technical English instead of *has* when all the main parts of a tool or other object are listed, as in: *A spade consists of a handle, a shaft and a blade*. The verb appears in reading texts later in this book and in Book 2. If your students are ready, you could introduce it here.

### 2 Functions

Section 2 contains an advertisement (main reading text) for a dynamo solar radio, a radio which is powered by a dynamo and by solar energy. A **dynamo** is a device (found on some bicycle lights) which changes (or **converts**) movement into electricity. If you turn the large handle of the dynamo radio, the movement creates current to power the radio. The adjective **solar** shows that the radio can be powered by sunlight through the **solar panel** on the top of the radio. Another source of power is **mains electricity** (*mains* is always plural in this context), supplied through the power sockets in a building. An **AC adapter** (also called a **power adapter**) is an external power supply for notebook computers and other electronic devices. It converts AC current (from the mains supply) to DC current (needed by the device). It also converts the mains voltage to a lower voltage for the device. The dynamo solar radio is an emergency radio that uses **external** and **internal** batteries: an internal battery is permanently fixed inside the device.

### 3 Locations

Section 3 deals with computer equipment and terms. Students will probably be familiar with the names of computer **peripherals** (external devices connected to a computer) such as **screen** (or **monitor**), **printer, webcam, speakers, mouse** and **keyboard**. In the audio in 1, the teacher and pupils are looking at a Windows screen, which has the **start button** at the bottom left of the screen, and the **close button** (marked with an X) at the top right. When you move your mouse or finger around, you see a **cursor** move around the screen. You **click on** items on the screen by pressing a mouse button or tapping with your finger. The difference between *on the left* and *to the left of* is dealt with in 4 on page 25. The phrases *on the left, on the right, etc.* are adverbial in function: they are not followed by noun phrases. The words/phrases *to the left of, to the right of, etc.* are prepositional in function: they are followed by noun phrases. *The computer is to the left of the keyboard* describes the location of the computer in relation to the keyboard.

#### Further reading online

Enter these search suggestions to find out more about the topics below:

**multi tools:** *swiss multi tool*

**basic physics topics, including dynamos:** *bbc bitesize physics dynamo*

**solar panels:** *howstuffworks solar cell*

**parts of tools:** (in Google Images) *main parts hand tools*

## Teacher's notes

### 1 Tools

#### Start here

#### 1 3.1

Ask students to look at the picture of the Multi Tool. Ask them to identify any of the tools on it that they can.

Play the recording for students to complete the text.

1 hammer 2 pliers 3 saw 4 blade 5 can opener

#### 3.1

This is the new Multi Tool! Use it at home. Use it on the building site. Use it when you travel. It has a hammer and a pair of pliers. It also has a saw, a blade and a can opener. The Multi Tool has everything you need! Only £29.99. Buy one now!

#### Listening

#### 2 3.2

Ask students to read the note in the margin. Point out the silent letter *c* in *scissors*. Tell them that some words in English include letters that aren't pronounced and *scissors* is one of them.

Play the recording for students to complete the dialogue.

After checking the answers with the class, you could go through the language notes with them. (See below.) Then ask students: *Do you have a Multi Tool?* and elicit the answer *Yes, I do./No, I don't*.

1 have 2 do 3 have 4 does 5 have 6 doesn't

#### 3.2

**A:** Do you have a Multi Tool?

**B:** Yes, I do.

**A:** Does the Multi Tool have a hammer?

**B:** Yes, it does.

**A:** Does it have a pair of scissors?

**B:** No, it doesn't.

#### 3 3.3

Ask students to read and listen to the phrases first without repeating them. Write: *a pair of pliers* and *a pair of scissors* on the board. Point out that the words underlined are stressed. Draw a circle round *a* and *of*, and tell students that these words have a schwa /ə/ sound and that you never stress these words. Say the phrases, stressing the syllables underlined. If asked, you could explain that we use 'a pair of' in front of a thing has two identical parts or pieces that are joined together, and we can say either 'a pair of pliers' or just 'pliers'. Then play the recording and ask students to listen and repeat the phrases. Make sure that they're pronouncing the phrases, using the correct stress.

#### 3.3

a pair of pliers

a pair of scissors

a blade

a can opener

a bottle opener

a screwdriver

#### Language

##### Present simple of *have*: question forms, short answers and negative forms

Go through the language box with the class. Tell students that you use *have* to talk about possessions and *Do you have?* to ask about possessions. Explain that in the present simple, you form questions with the auxiliary verb *do* and that when you use questions with *it/he/she*, you use *does* not *do*. Point out the answers to the questions are *Yes, I do./No, I don't.* or *Yes, it does./No, it doesn't.* This is because they sound softer and less abrupt than just *Yes* or *No*.

If students ask about *Have you got*, explain that this question is also used in British English, but *Do you have* is more common in American English. Note that *have* is used in this book because it's easier for students to acquire as it's used with the auxiliary *do* in the same way as other verbs in the present simple.

Tell students that they'll find more information showing all forms of *have* in the *Grammar summary* on page 100 of the Course Book.

- 4 Ask two confident students to read through the example first. Then demonstrate the activity, using the prompts, with another student. Take the part of A and ask the student to take the part of B. Substitute the information in the dialogue with one of the choices on the right and read the dialogue out.

Go round the class as students are practising their dialogues and make notes of any mistakes that they make. Go through these mistakes at the end of the activity with the class.

- 5 Put students in pairs. Ask them to design a multi tool for their work.

##### Extra activity

Students could then join another pair. Each pair asks the other pair about their multi tool, e.g. *Does it have a screwdriver? Yes, it does./No, it doesn't*, and make a rough drawing of it. They then check their drawings with the other pair.

## Reading

- 6 Ask students to look at the picture of the Survival Tool. They could work with a partner to label the tool. Do not confirm answers at this stage. Point out that you say *wrenches* in American English for *spanners* and that *wrench* is another English word which includes a letter that isn't pronounced, i.e. the *w* isn't pronounced.
- 7 Ask students to read the product review about the Survival Tool and check their answers to 6.

- 1 screwdriver
- 2 ruler
- 3 blade
- 4 can opener
- 5 pliers
- 6 cover
- 7 pick
- 8 bottle opener

## Speaking

- 8 Ask students to look back at the pictures and information about the Survival Tool and the Multi Tool. They then ask and answer questions about the tools. Remind them of the pronunciation for *a pair of...*

## Vocabulary

- 9 Ask students to look at the pictures of the tools and to identify what tools they are. Then ask them to match the words with the parts labelled.

Point out that not all the parts of the hammer and the pliers have been labelled. Ask students to label the other parts (i.e. the shaft and handle of the hammer, and the handles of the pliers).

- 1 head
- 2 handle
- 3 shaft
- 4 blade
- 5 jaws

- 10 Ask students to think about some tools that they use at work and to draw them on a piece of paper. They label the parts with words from 9 and then make sentences as in the example about their tools. Point out that with *it*, you use *has* not *have* in the present simple.

Students could then describe their tools to each other in small groups, or you could get them to stand up in front of the class. Remind them to point to the parts as they're describing their tools.

## Speaking

- 11 Ask students to look at the product comparison table as you read out the two example sentences. Then ask them to make some similar comparisons for the three products. Remind students to use *has* for positive sentences and *doesn't have* for negative sentences.

## Writing

- 12 Students now write a short comparison of the three products in 11. They could do this either in class or for homework.

When students have finished, you could ask them to compare their answers with a partner before you check their work.



## 2 Functions

### Start here

- 1 Ask students to look at the pictures of the four different power sources and match them with the words. They can then compare their answers with a partner before you check with the class.

Write: *electricity*, *adapter*, *dynamo* and *batteries* on the board, underlining the syllable with the stress. Tell them that you don't pronounce the middle *e* in *batteries*. Then get students to repeat the words after you.

1 B 2 C 3 D 4 A

### Reading

- 2 Ask students to look at the parts of the emergency radio in the web page advertisement in 4. Ask them to label the radio with the words in the box. Do not confirm answers at this stage.

### 3 3.4

Play the recording for students to listen and repeat the words. Make sure that they're pronouncing the words correctly. Write *speaker*, *handle*, *phone charger*, *radio*, *solar panel*, on the board underlining the stressed syllable in each word. Then get students to repeat these words.

### 3.4

Bluetooth speaker  
clock  
handle  
phone charger  
radio  
solar panel  
torch

- 4 Ask students to read the description of the emergency radio and check their answers to 2.

1 handle 2 alarm 3 clock 4 radio  
5 torch 6 phone charger 7 Bluetooth speaker

- 5 First, check that students understand the meaning of *function*, i.e. the purpose or job of something. Then ask them to look back at the photo of the radio and the reading text, and explain the functions of the four parts of the emergency radio.

1 The USB adapter connects the mains electricity supply to the radio.  
2 The handle turns the dynamo.  
3 The dynamo produces electricity and charges the internal battery.  
4 The solar panel changes the Sun's energy into electricity and charges an internal battery.

- 6 Students match the parts of the radio with their function. They can then compare their answers with a partner.

1 g 2 e 3 a 4 d 5 h 6 b 7 c 8 f

- 7 Students make sentences from the parts and functions in 6 as in the example.

1 The clock tells the time.  
2 The phone charger charges your phone.  
3 The torch shines a light.  
4 The radio plays radio signals.  
5 The alarm makes a loud noise.  
6 The solar panel makes electricity.  
7 The handle turns the dynamo.  
8 The Bluetooth speaker plays music from a phone.

## Language

### Present simple: third person singular

Go through the language box with students. Here, students are presented with the present simple focusing on the third person singular. Tell them that in positive sentences you use the infinitive. You only change the form of the verb in the third person singular (*he, she and it*), and also for singular nouns. Don't worry too much if your students make frequent errors with this at this level as this is one of the most difficult things for learners to acquire, and will probably take them many years of practice. Note that in Unit 5 they will practise irregular spellings of verbs in the third person singular.

Point out the contracted form in the negative and encourage students to use *doesn't* when speaking as this sounds more natural. Remind them that you use *does* in questions and short answers with *it*.

Tell students that they'll find more information showing all forms of the present simple in the *Grammar summary* on page 101 of the Course Book.

## Speaking

- 8 Go through the example question and answer with the students. Remind them that you use the same auxiliary in short answers as in the question.

Put students in pairs to take turns asking and answering questions, using the words from 6.

- 9 Ask students to look at the pictures and match them with the words in the box.

1 tighten 2 loosen 3 grip 4 cut 5 drive in

- 10 You could remind students of the tools first by miming how you use them for students to guess what they are. For example, mime using a pair of scissors to cut some paper, and ask students what tool you're using. Students then make sentences using the words from the three columns. Ask individual students to read out their answers, checking that they've added -s to the verb where necessary.

A spanner tightens and loosens nuts and bolts.  
Pliers grip bolts and wire.  
A screwdriver tightens and loosens screws.  
A chisel cuts wood and metal.  
Scissors cut paper and string.  
A saw cuts wood.  
Hammers drive in nails.

### Extra activity

Make dialogues, using the following words: *spanner, pliers, screwdriver, scissors, chisel, clocks, solar panel* and *Bluetooth speakers* to practise present simple forms.

A: *What does a spanner do?*

B: *It tightens and loosens nuts and bolts.*

A: *What do pliers do?*

B: *They grip nuts and bolts.*

## Social English

- 11 Ask students to think of job titles that are useful for them in the work they do now or the work they want to do in the future. Tell them to use their dictionaries to help them.

- 12 Ask students to read through the example dialogue. Then write *What do you do?* and *Where do you work?* on the board. Tell students that the words underlined are stressed, and the *do you* is never stressed in questions. These two words run together and are pronounced /dʒə/. Get students to repeat the questions after you. Then remind them to use *does* in the question for *he* and *she*.

If possible, allow students to walk around the class to find out information about the other students.

When they've finished, you could ask students about themselves and other members of the class in a feedback session.



### 3 Locations

#### Start here

#### 1 3.5

Write *top*, *bottom*, *left* and *right* on the board. Then draw a square. Point to the bottom of the square and ask students to say what part of the square it is. Then point to the other sides of the square and ask students to name the location. Keep the square on the board for 2.

Tell students that they're going to listen to a computer lesson. Play the recording for them to complete the dialogue with the words in the box. When checking their answers, you could ask for a volunteer student to come to the board and point to the correct positions on the square for the start and close buttons. Point out the contraction used in *Where's* for *Where is*.

- It's at the bottom. On the left.
- It's on the right. At the top.

#### 3.5

- A:** OK, now put the cursor on the START button.  
**B:** Where's the START button?  
**A:** It's at the bottom. On the left. Do you see it?  
**B:** Yes. Is that it?  
**A:** Yes, that's correct. ... Now, move the cursor up to the CLOSE button.  
**B:** Where's that?  
**A:** It's an X. It's on the right. At the top.  
**B:** Is that it?  
**A:** Yes, that's it. Now click.

#### Vocabulary

- 2 Draw a circle on the left of the square on the board and ask: *Where's the circle?* And elicit *On the left*. Then rub it out and draw it again at the top of the box and elicit *At the top*. Then go through the language box with the students. Ask students to read the information in the box in the margin, then to look at the nine TV monitors and match them with their locations.

1 G 2 I 3 H 4 D 5 F 6 B 7 A 8 C 9 E

### Reading

- 3 Ask students to look at the picture of the computer station. Ask them a couple of questions, e.g. *Where is the lamp?* (It's at the top on the right), *Where's the keyboard?* (It's at the bottom in the middle). Then draw their attention to the description of the computer station and tell them that there are six mistakes in the description about where the computer items are. Tell them to read through the description first. Then look at the computer station and find and underline the six mistakes in the text. They should then correct the information.

Students can compare their answers with a partner before you check them with the class. Point out that you can change the order of the information by saying *Put the lamp on the right at the top*, *Put the printer on the left at the top*, etc.

- 1 Put the lamp at the top on the ~~left~~ right.
- 2 ... put the printer at the top on the ~~right~~ left.
- 3 Then put the computer at the ~~top~~ in the middle ~~bottom~~ on the left.
- 4 ... put the web cam at the ~~bottom~~ on the left ~~top~~ in the centre/middle.
- 5 Finally, put the keyboard at the bottom ~~on the right~~ in the centre/middle.
- 6 ... and put the mouse at the bottom ~~in the centre~~ on the right.

#### Extra activity

Tell students to ask and answer questions about where the TV monitors in 2 are, using the phrases in the language box with a partner, e.g. A: *Where's TV monitor F?* B: *It's in the centre on the left*.

## Language

- 4 Ask students to look back at the computer station in 3 and circle the sentence T (true) or F (false).

The statements are all true.

- 5 Ask students to look at the diagram and discuss the question.

You use *ON the left* to describe the general location of something.

You use *TO the left OF* to give the exact position of something in relation to another object. You name the object the thing is to the left of.

- 6 Students complete the sentences with the words in the box first, without looking back at 3. When they've finished, they can look back at the computer station to check their locations are correct.

1 at, in, to, of, below

2 at, on, to, of, above

- 7 Ask students to look back at the computer station in 3 once more and make sentences about the locations of the objects listed.

*Possible answers:*

1 The mouse is to the right of the keyboard. It's below speaker 2.

2 The computer is at the bottom on the left. The computer is below speaker 1.

3 The lamp is at the top on the right. The lamp is above speaker 2.

4 The screen is in the centre. It's to the right of speaker 1 and to the left of speaker 2. It's above the keyboard and below the webcam.

## Extra activity

Students could work with a partner and get their partner to guess the object from the computer station by describing the location. If their partner guesses correctly, it's their turn to ask a question.

A: *It's at the bottom in the centre.*

B: *The keyboard?*

A: *Yes. It's in the middle on the left.*

B: *The computer?*

A: *No. Speaker 1. It's in the centre ...*

## Task

- 8 Put students in pairs. Ask Student A to turn to page 113. Ask students to read the instructions. Check that they know all the words. Tell them that the blank boxes represent the items in their list that are missing in their picture. Student A begins by asking Student B questions to find the locations of their items in their picture. Student A then writes the name of the missing item in the blank box. They then swap roles. Remind students of the phrases from the language box on page 24, as well as the phrases from 6 before they start. Ask students to compare their finished pictures at the end of the activity.

## Contents

### 1 Directions

#### Objectives

In this section, students will ...

- label a jetpack man's movements with adverbs of direction
- complete a form in pairs about the directions planes and helicopters can fly
- read a text about planes and helicopters and check answers
- study question forms and short answers for *can/can't/cannot* + verb + adverb of direction
- complete sentences with *can/can't*
- practise dialogues in pairs about directions things can go
- read a set of instructions about movements and answer questions
- read a text and check answers
- label movements in a diagram
- listen and choose between easily confused numbers (e.g. 19/90) in the form of angles
- answer questions about robot arm movements
- complete a text with *is/isn't, has, can/can't* about robot arm movements

### 2 Instructions

#### Objectives

In this section, students will ...

- do a quiz by choosing the correct speeds
- listen and check answers to the quiz
- dictate different speeds for a partner to write down
- label a diagram of a remote control transmitter to prepare for the reading
- discuss what controls do to a model plane in groups to prepare for the reading
- check answers from a manual for transmitter controls
- identify what the pronoun reference *it* refers to in the text
- match instructions for using a joystick with actions
- practise dialogues using *can* in questions
- ask a partner what they can or can't do

### 3 Actions

#### Objectives

In this section, students will ...

- answer questions about a diagram of forklift truck controls to prepare for the listening
- identify the controls in the diagrams by reading the text in an instruction manual
- describe the movements of pictures of forklift trucks using words and phrases from the manual
- roleplay a driving lesson – giving instructions and acting them out
- write instructions about how to operate something and draw a diagram for it
- write sentences from notes
- in pairs, have a driving lesson for a forklift truck and identify the correct picture by following the instructions that the instructor gives



## Briefing

This unit deals with ways of communicating about directional movement, needed in a range of engineering fields and industries including robotics, mechatronics and transportation.

### 1 Directions

Section 1 introduces adverbs and adverbial phrases indicating **direction** of movement. This is done by examining the capabilities of different vehicles. Cars and other land vehicles can move **forwards** and **backwards**. They can also **turn left** and **turn right**. Turning left combines two directions: forwards + leftwards. Normal land vehicles cannot move directly **sideways** to the left or right. A normal aeroplane can move forwards and turn left or right like a car, but it is not able to **reverse** (go backwards). In addition, it can move **diagonally upwards** (upwards at an angle) and **diagonally downwards**. These movements combine two directions: forwards + upwards/downwards. A vertical take-off and landing (VTOL) aircraft such as the Harrier Jump Jet can do everything a normal plane can do, but it has two additional directions: **straight up (vertically up)** and **straight down (vertically down)**. A person wearing a jetpack, like the one on page 26, can move in the same directions as the VTOL; in addition, they can move sideways. The most versatile aircraft is the helicopter, which can move in all the directions of an aeroplane and jump jet, and can do three additional movements: it can go sideways, it can reverse, and it can **rotate on its vertical axis**. (The vertical axis runs from the top to the bottom of the helicopter; the horizontal axis runs from the front to the back.) Planes and helicopters can rotate on their horizontal axis: this is also called **rolling** (see below). In addition, helicopters can **hover** in the air (without moving in any direction). (Note that the variations *upward*, *downward*, *forward* and *backward* (with no -s ending) also occur in English, but in this book only the -s form is used in order to keep matters simpler for students.) Section 1 also deals with **robotic arms**. Robotic engineers use the concept of **degrees of freedom**. A human arm has seven degrees of freedom, which means seven distinct directions: three in the wrist (up + down, sideways and rotating), one in the elbow, and three in the shoulder. The robot arm in 11 only has six degrees of freedom (the robot shoulder has one less than the human shoulder: it can rotate on a base and move up and down, but not sideways). However, it has one advantage over the human arm: the wrist and shoulder can rotate 360°, whereas the human versions have more limited angles of rotation.

### 2 Instructions

Section 2 introduces a **quadcopter drone** which is operated by a **remote controller**. A **drone** is an aircraft that does not have a pilot but is controlled remotely by someone, usually on the ground. A quadcopter is a special type of drone, like a helicopter but with four **rotors** (or **rotating blades**). All the possible movements of the quadcopter are listed in 8 (right-hand column) on page 29. Some names of controls (found on the remote controller for the drone) are also introduced: **joystick** and **switch**. A joystick can be moved in all directions – up, down, to the left and to the right. A switch has two positions: on and off. In the quiz in 1, the word **per** is introduced when talking about speeds. If something travels at 1228 km *per hour*, it travels 1228 km *in each hour*.

### 3 Actions

Section 3 deals with directions of movement of a **forklift truck** and its controls. The forks can move up and down (the forks remain horizontal), and they can also **tilt** up and down (the front of the forks moves higher or lower than the back of the forks). The tilt control allows the forks to pick up and put down loads easily.

#### Further reading online

Enter these search suggestions to find out more about the topics below:

**movements of planes and helicopters:** *howstuffworks helicopters*

**radio-controlled drones and quadcopters:** *rc drone quadcopter*

**forklift trucks:** *osha how operate forklift*

**robotic arms:** *howstuffworks robotic arm*

**jetpack:** *YouTube personal jetpack new york*

## Teacher's notes

### 1 Directions

#### Start here

- 1 Ask students to look at the photo. Ask them what the man has on his back (it's a jetpack) and ask *What can the man do?* (fly) Then ask them to look at the words in the box which describe the jetpack man's movement. Make sure students can pronounce all of the words correctly. The students then label the movements of the jetpack man with the words in the box.

1 up 2 sideways 3 backwards 4 down 5 forwards

- 2 Ask students to look at the boxes describing movement in the margin. Then ask them to think about planes and helicopters and what directions they fly in.

Put students in pairs. Tell them to discuss the question and tick the boxes in the form according to which directions planes and helicopters fly. Do not confirm answers at this stage.

#### Reading

- 3 Ask students to read the text and check their answers to 2. Then ask students if helicopters can turn on their vertical axis to check they understand *rotate*. Draw a simple diagram of this on the board if necessary.

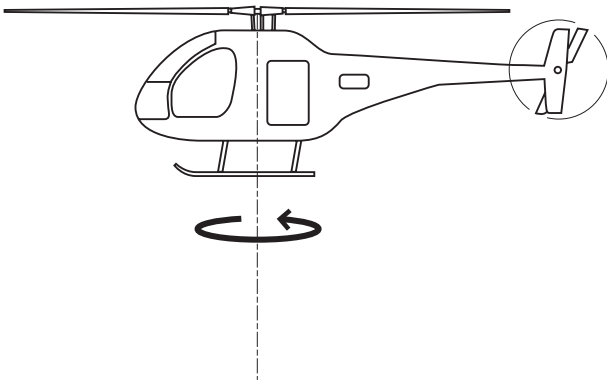

| Direction   | Plane          | Helicopter   |
|-------------|----------------|--------------|
| forwards    | ✓              | ✓            |
| backwards   |                | ✓            |
| up and down | ✓ (diagonally) | ✓ (straight) |
| sideways    |                | ✓            |

## Language

### Can

Go through the language box with the class. Explain that you use *can* here to talk about ability, i.e. whether it is possible or it isn't possible to do something. You form sentences with *can/can't* + infinitive without *to*. You say *It can fly forwards*, not ~~*It can to fly forwards*~~. You put *can* before the subject in questions: *Can the plane fly sideways?* and you use *can* for the short answer for the questions: *Yes, it can./No, it can't*. Point out the two negative forms: *can't* and *cannot*. Explain that you normally use *can't* when speaking and *cannot* for formal written English.

Point out that *can* is pronounced /kən/ in positive sentences and /kæn/ in questions. You pronounce *can't* /kɑ:nt/. Ask individual students to read out the sentences in the table and check that they're pronouncing *can* and *can't* correctly.

Tell students that they'll find more information on *can* in the *Grammar summary* on page 101 of the Course Book.

- 4 Ask students to complete the sentences with *can* and *can't*. Tell them to look back at the text in 3 to help them if necessary. They can then check their answers with a partner before you check them with the class.

- 1 can; can't
- 2 can't; can
- 3 can't; can
- 4 can't; can

### Speaking

- 5 Put students in pairs. Tell them to take it in turns to ask and answer the questions about the movements of helicopters, rockets and planes. Go round the class checking students' pronunciation and making notes on any mistakes they make. At the end of the activity, go through any problems with the class.

## Task

- 6 Pre-teach vocabulary for the parts of the body used in this activity. Hold out your arm in front of you and indicate that this is your *arm*. Point to your elbow and ask students what part of your arm it is. Then point to your wrist and shoulder and elicit what they are. Then ask students to repeat the words as you say and point to your own *wrist*, *shoulder* and *elbow*. Make sure students can pronounce the words correctly. Point out that *wrist* is another word which has a silent letter (*w*).

Now put students in pairs. Ask them to read the instructions and discuss the questions with their partner. Do not confirm answers at this stage.

## Reading

- 7 Ask students to look at the diagram in the text and pre-teach the word *pivot*. Point to your wrist, and demonstrate how your hand can move from this point and tell students that your wrist is an example of a pivot, i.e. your hand turns from it. Explain that *forearm* is the lowest part of your *arm*.

Ask students to read the text and check their answers to 6.

1 three 2 three 3 one

- 8 Ask students to look back at the diagram in 7 and find the information in the text to label the movements with the words from the box.

1 move up and down  
2 rotate  
3 move sideways  
4 move up and down  
5 move up and down  
6 rotate  
7 move sideways

## Listening

- 9  4.1

This exercise helps students to differentiate between numbers ending in *-ty* and *-teen*. Play the recording for students to choose the correct answer.

Remind students that the stress is on the last syllable when you say the numbers ending with *-teen*, e.g. *nineteen*, in isolation. Then explain that you put the stress on the first syllable in numbers ending in *-ty*, e.g. *ninety*. Play the recording again for students to repeat the numbers, and then get students to say both sets of numbers, emphasising the different stress on the numbers.

1 a 2 b 3 b 4 a

## 4.1

- 19 degrees.
- 40 degrees.
- 70 degrees.
- 118 degrees.

### Extra activity

Play bingo with numbers to practise differentiating between *-teen* and *-ty* numbers.

Ask students to choose three numbers from 13–19, and three numbers from the decades 30–90 and write them down on a piece of paper. Call out numbers randomly, and make a note of the ones you've called. Ask students to tick the number if they hear them. The first student to tick all their numbers calls out *Bingo*. Check that this student has ticked their numbers correctly. If not, continue until someone has.

## Task

- 10 Put students in small groups and ask them to look at the diagram of the robot arm in the text at the bottom of the page. They discuss the questions in their groups. Go round the class monitoring, but do not confirm answers at this stage.

## Language

- 11 This exercise revises *be* and *have* and the modal verb *can*. Ask students to read the text about the robot arm and complete it with the words in the box. After you have checked their answers, they can compare the text with the answers they gave to the questions in 10.

Answers to 10:

1 six 2 a) the shoulder

Answers to 11:

1 is 2 has 3 is 4 has 5 can 6 can 7 can 8 is  
9 has 10 can 11 isn't 12 has 13 can 14 can  
15 can't

## 2 Instructions

### Start here

- 1 Tell students that they're going to do a quiz about speeds. Go through the abbreviations for speeds in the box in the margin with the class first. Then allow students a couple of minutes to do the quiz on their own. They can then compare their answers with a partner. Do not confirm answers at this stage.

### Listening

#### 2 4.2

Play the recording for students to check their answers to 1. Then ask students to say the correct speed out loud for each of the answers to 1.

Point out that with thousands, you write a comma after the thousands, e.g. 12,500. However, if the number has four figures, e.g. 2500, you can write this number with or without a comma. In the Course Book, four digit numbers are written without a comma.

Tell students that in British English for numbers in their hundreds you say *and*, e.g. *One hundred and fifteen*. However, in American English you say *One hundred fifteen*. Also explain that you can say *a hundred* or *one hundred*, and *a thousand* or *one thousand*.

1 b 2 b 3 a 4 a 5 a 6 a

#### 4.2

- 1 The speed of light through a vacuum is about 299,792 kilometres per second.
  - 2 Sound travels at about 1200 kilometres per hour.
  - 3 The maximum land speed is about 1228 kilometres per hour.
  - 4 The maximum speed of a boat on water is 511 kilometres per hour, which is about 142 metres per second.
  - 5 The Earth rotates at 1000 miles per hour.
  - 6 The Earth moves around the Sun at 67,000 miles per hour.
- 3 Put students in pairs. Ask students to write down some speeds, using *kilometres*, *metres* and *miles*. Tell them not to show their speeds to their partner. After they've dictated their speeds, students can check that their partner has written the correct speeds down.

## Vocabulary

- 4 Ask students to look at the diagram and tell you what it is (a transmitter for a quadcopter drone (a drone with four rotors) like the one in the photo).

Demonstrate the movement of *tilt* and *roll* by moving your hand. Then ask them to label the remote control with the words in the box. Do not confirm answers at this stage. They will be checking their answers in the reading text on page 29.

### Task

- 5 Put students in small groups to discuss the questions about the drone's movements. Go round monitoring and helping with vocabulary, but do not confirm answers at this stage.

## Reading

- 6 Students look at the diagram of the transmitter on page 28 at the same time as they read the user manual. They then check their answers to 4 and 5.

Answers to 4:

1 antenna 2 handle 3 display 4 joystick  
5 power switch

Answers to 5:

### LH joystick:

- 1 Push it up (away from you), the drone goes up. Pull it down (towards you), the drone goes down.
- 2 Push it to the left, the drone rotates to the left. Push it to the right, the drone rotates to the right.

### RH joystick:

- 3 Push it up, the drone moves forwards. Pull it down, the drone moves backwards.
- 4 Push it to the left, the drone moves (sideways) to the left. Push it to the right, the drone moves (sideways) to the right.

### Extra activity

Ask students to find the opposites in the text for the following words: *move left, away from you, ascends, pull, left-hand, forwards.*

- 7 Ask students to look at the pronouns circled in the text in 6. Tell them to read the information in the sentences that come before these pronouns to help them find out what *it* refers to.

You could then ask them what *it* refers to in line 4 and line 6.

1 c 2 a

- 8 Ask students to look back at the text in 6 and the diagram of the transmitter in 4 to help them to match their actions with the drone's actions.

1 b 2 d 3 a 4 h 5 c 6 f 7 e 8 g

## Speaking

- 9 Put students in pairs. Tell them to read the example dialogue and to make similar dialogues with the information in 8.

## Social English

- 10 Put students in pairs. Ask them to look at the first picture and go through the example with them. Preteach or check that they know the vocabulary for the other pictures. You could write the phrases, e.g. *ride a horse*, on the board and ask them to identify the picture. Leave these phrases on the board as reference. Then they take turns to ask and answer questions about what they can or can't do.

### Extra activity

Ask students to think of four or five more activities, and to write questions using *Can ...?*, e.g. *Can you skateboard?* They then walk round the class and find students who can do their activities. Tell them to make a note of their names.

At the end of the activity, you can ask a few students what their classmates can do.



### 3 Actions

#### Start here

- 1 Ask students to look at the diagrams of the forklift truck and its controls and answer the questions.

1 two 2 four 3 on the left

#### Reading

To revise movements, ask students to stand up. Give them instructions to move forwards, backwards, left, right and sideways, stand up and sit down. You could also pre-teach *reverse* at this stage.

- 2 Ask students to read the manual straight through, ignoring the spaces.

Now complete the first space with the class so that they know what to do. Ask them to read the information about the first control again: *On the left is a lever. This is the direction lever (1\_\_\_\_\_)*, and ask them to look back at the diagram of the controls at the top right of the page. Ask students what letter the direction lever is (G) and tell them to write it down in the first space.

Students then do the rest of the exercise on their own. They can compare their answers with a partner before you check with the class.

1 G 2 A 3 B 4 C 5 D 6 F 7 E

- 3 Ask students to look at the pictures of the movements of the forklift truck. Point out the arrows showing the movements of the forks. Ask students what direction the forks in each of the pictures is moving in. Then tell them to look back at the manual and find and note down the description of the movements that matches the movements of the forklift truck in the pictures.

- A the fork tilts down
- B the fork tilts up
- C the truck moves forwards
- D the fork moves down
- E the truck reverses
- F the fork moves up

## Speaking

- 4** Find out how many students can drive a car. If there are students who can't, pair them up with a student who can. This student will be their driving instructor in the task.
- Point out the note in the margin and explain that when you turn the car round to go in the opposite direction, you say *do a U-turn*. Go through a few of the instructions with the class first in order to pre-teach *go slowly*, *go faster*, by miming the instructions yourself as if you're driving a car, and then applying the brake gradually for *slow down*.
- Put students in pairs. Ask them to read the instructions and the example. Tell them to position themselves next to each other to simulate the driving lesson. Student A then gives instructions for Student B to act out the instructions. Go round the class, checking that the learner driver is following the instructions correctly.

## Writing

- 5** Ask students to write short instructions like the ones in 4, for one of the jobs listed, and draw a diagram based on their instructions.
- They could do this exercise either in class or for homework. They could then swap their instructions with a partner, for their partner to check before you check their instructions yourself.
- 6** Go through the example with the class so that they know what to do. Point out the comma in the sentence separating the two clauses. Students then write full sentences from the notes.
- 1 When you pull lever C backwards, the fork tilts down.
  - 2 When you push lever B forwards, the fork moves up.
  - 3 When you turn the steering wheel to the right, the truck turns right.
  - 4 When you pull lever G backwards, the truck reverses.
  - 5 When you press the brake pedal, the truck stops.
  - 6 When you press the accelerator, the truck goes faster.

## Task

- 7** Put students in pairs. Ask Student A to turn to page 115. Explain that they have both got the same pictures of the forklift truck but that they're in a different order. Tell students to read the instructions for their role.
- Student B takes the role of the driving instructor first and gives Student A instructions to follow according to the order of their pictures. Student A follows the instructions and writes the correct sequence of the pictures in the box provided. They then swap roles.

Student A – the correct sequence of instructions is:  
4, 8, 6, 3, 5, 1, 2, 7

Student B – the correct sequence of instructions is:  
6, 7, 4, 1, 5, 3, 8, 2

# Review Unit B

## Answer key

- 1**
- 1 Does John have the spanners?
  - 2 Do the students have a holiday tomorrow?
  - 3 Does the Multi Tool have a screwdriver?
  - 4 Do these bikes have strong brakes?
  - 5 Does the radio have an internal battery?
  - 6 Do those houses have solar panels?
- 2**
- 1 No, I don't have a car. I have a motorbike.
  - 2 No, my brother doesn't have a Chromecast. He has a Fire TV Stick.
  - 3 No, the Multi Tool doesn't have scissors. It has a knife blade.
  - 4 No, we don't have English today. We have Science.
  - 5 No, my radio doesn't have batteries. It has a dynamo.
  - 6 No, the pliers don't have plastic handles. They have metal handles.
- 3**
- 1 The Multi Tool doesn't have a spanner. It isn't very useful.
  - 2 We don't have an AC adapter. We can't switch on the computer.
  - 3 I'm a technician, but I don't have my tools here. I can't repair your TV.
  - 4 The electricity is off and we don't have any batteries. You can't use the radio now.
- 4**
- 1 No, I can't.
  - 2 No, he isn't.
  - 3 Yes, it does.
  - 4 No, they don't.
  - 5 Yes, I am.
  - 6 No, it doesn't.
  - 7 No, I'm not.
  - 8 Yes, they can.
- 5**
- 1 does 2 do 3 turns 4 produces 5 charge 6 use  
7 uses 8 has
- 6**
- 1 jaws 2 handles 3 blades 4 handle 5 handle  
6 shaft 7 blade 8 head 9 shaft 10 handle

- 7**
- 1 A pair of pliers has two handles and two jaws.
  - 2 A pair of scissors has two handles and two blades.
  - 3 A spade has a handle, a shaft and a blade.
  - 4 A hammer has a handle, a shaft and a head.
- 8**
- Five screwdrivers. They're at the top, on the left.  
Four spanners. They're at the top, in the middle/centre.  
One knife. It's at the top, on the right.  
One hammer. It's in the middle/centre, on the left.  
Three chisels. They're in the middle/centre, on the right.  
One saw. It's in the middle/centre.  
Two pairs of pliers. They're at the bottom on the left.  
One pair of scissors. It's at the bottom, on the right.  
Two torches. They're at the bottom, on the right.
- 9**
- The screwdrivers are to the left of the spanners and above the hammer.  
The spanners are to the right of the screwdrivers and to the left of the knife. They're above the hammer and the chisels.  
The knife is to the right of the spanners. It's above the chisels.  
The hammer is to the left of the chisels. It's below the screwdrivers and above the saw.  
The chisels are to the right of the hammer. They're below the knife and above the saw.  
The saw is below the hammer and the chisels. It's above the pliers and the scissors.  
The pliers are to the left of the scissors. They're below the saw.  
The scissors are to the right of the pliers. They're below the saw and above the torches.  
The torches are to the right of the pliers. They're below the scissors.

- 10** 1 helmet 2 (a pair of) pliers 3 solar panels 4 nuts  
5 antenna 6 dynamo
- 11** 1 are 2 do 3 do 4 is 5 does 6 is 7 does 8 does  
a) works b) am c) is d) comes e) am f) study  
g) study h) is
- 12** 1 e 2 b 3 f 4 g 5 d 6 h 7 c 8 a
- 14** 1 knife 2 build 3 building 4 scissors 5 wrist  
6 ascend 7 descend 8 right 9 tighten
- 15** 1 switch 2 wheel 3 button 4 lever 5 display  
6 pedal 7 stick
- 16** a printer, an AC adapter, a pair of speakers, a keyboard,  
an amplifier, a pair of headphones, a pair of earphones,  
some nuts, some bolts, a pair of pliers
- 17** 1 This opener can open bottles, but it can't open tins.  
2 These spanners can't tighten the M12 bolts, but they  
can loosen the M5 nuts.  
3 That antenna can receive radio signals, but it can't  
transmit them.  
4 A rocket can fly straight up, but it can't reverse.  
5 Passenger planes can't fly sideways, but they can turn  
left and right.  
6 I can drive a car, but I can't operate a forklift truck.
- 18** The yellow square
- 19** 1 H 2 A 3 G 4 B 5 J 6 E 7 C 8 I 9 D 10 F

## Projects

- 20** At the end of every Review Unit is a project. Students can  
do their research on the internet or in a library and in their  
own language if they wish. They must then write their  
results in English.

Tip: Key the name of your industry into a search engine.  
Add other keywords such as *technician*, *job*, *career*.

Example: Construction Industry: *structural engineer*, *quantity  
surveyor*, *site manager*, *architectural technician*, etc.

- 21** Students can use a good dictionary or an internet search  
engine.

Tip: To find the meaning of a word in Google, type  
*definition* and then the word.

multi- = many; multimedia = using many types of media  
(sound, pictures, film, text on screen)

therm- = heat; thermometer = instrument to measure  
heat

kilo- = a measure of 1000; kilometre = 1000 metres

## Quick test answer key

### Part 1: Vocabulary and grammar

- 1** 1 b 2 a 3 e 4 d 5 c
- 2** 1 a pair of scissors 3 a pair of pliers  
2 a hammer 4 a spade
- 3** 1 vehicle 2 computer 3 tool
- 4** 1 A is at the bottom, on the right.  
2 B is at the top, on the left.  
3 C is in the centre/middle, to the right of D.
- 5** 1 have 2 doesn't 3 Do 4 don't 5 work  
6 cut 7 can't 8 can't
- 6** 1 is 4 do 7 has  
2 is 5 Does, have 8 Can  
3 Do, have 6 doesn't 9 can't
- 7** 1 Drive fast 4 Do a U-turn  
2 Slow down 5 Stop  
3 Turn left

### Part 2: Reading and writing

#### Reading

Possible answers:

- it's ultra slim, it's easy to use, it takes great photos, it  
has lots of useful apps, it has a beautiful cover
- a calendar, a calculator
- pictures, sounds and text
- it has a low battery life, you can't play games on the  
phone, it doesn't have a good alarm
- No, you can't.

#### Writing





- When you turn the key, the engine starts.
- When you push the accelerator pedal, the car  
accelerates.
- When you push the brake pedal, the car stops.
- When you turn the steering wheel, the car turns left  
or right.
- When you turn/switch off the engine, the car stops.

# Review Unit B | Quick test

Total \_\_\_\_\_/50

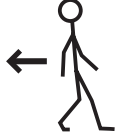
## Part 1: Vocabulary and grammar

### 1 Match the words with the movements.

- 1 backwards a) 
- 2 down b) 
- 3 forwards c) 
- 4 sideways d) 
- 5 up e) 

(5 marks)

### 2 Name the object. Use the words in the box.

a hammer a pair of pliers a pair of scissors  
a spade

- It has two blades and two handles. \_\_\_\_\_
- It has a head, a shaft and a handle. \_\_\_\_\_
- It has two handles, a shaft and two jaws. \_\_\_\_\_
- It has a blade, a shaft and a handle. \_\_\_\_\_

(4 marks)

### 3 Add the headings in the box to the words.

computer tool vehicle

- \_\_\_\_\_ bicycle, car, motorbike, plane, truck
- \_\_\_\_\_ amplifier, monitor, mouse, printer, scanner
- \_\_\_\_\_ knife blade, pick, saw, screwdriver, wrench

(3 marks)

### 4 Use the words in the box and the correct prepositions to describe the positions of A, B, C and D in the square. You will need to use one of the words twice.

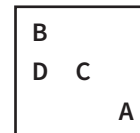

bottom right left top centre

- A is \_\_\_\_\_ the \_\_\_\_\_, \_\_\_\_\_ the \_\_\_\_\_.
- B is \_\_\_\_\_ the \_\_\_\_\_, \_\_\_\_\_ the \_\_\_\_\_.
- C is \_\_\_\_\_ the \_\_\_\_\_, \_\_\_\_\_ the \_\_\_\_\_ D.

(6 marks)

### 5 Choose the correct word to complete the sentences.

- I (1) *has/have* a new radio, but it (2) *doesn't/don't* have batteries.
- A: (3) *Do/Does* you work at BMW?  
B: No, I (4) *don't/doesn't* work at BMW. I (5) *work/works* at Fiat.
- These scissors can (6) *cut/cuts* paper.
- I (7) *can/can't* find North with my compass.
- Planes (8) *can/can't* fly backwards.

(8 marks)

**6 Complete the dialogue. Use all the words in the box.**

can can't do do does doesn't have have  
has is is

- A:** Hello. (1) \_\_\_\_\_ this shop open?  
**B:** Yes, it (2) \_\_\_\_\_. Can I help you?  
**A:** (3) \_\_\_\_\_ you \_\_\_\_\_ any Multi Tools?  
**B:** Yes, we (4) \_\_\_\_\_. This is the new model.  
**A:** (5) \_\_\_\_\_ it \_\_\_\_\_ a bottle opener?  
**B:** Er, no, it (6) \_\_\_\_\_, but it (7) \_\_\_\_\_ a can opener.  
**A:** (8) \_\_\_\_\_ it open bottles?  
**B:** Sorry, no, it (9) \_\_\_\_\_.

(9 marks)

**7 Read the situation and then write the instruction. Use the words in the box.**

do a U-turn drive fast slow down stop turn left

- 1 I need to go to the bank. It's 4.50 pm. The bank closes at 5.00. \_\_\_\_\_.
- 2 There's a slow car in front. \_\_\_\_\_.
- 3 The bank is in the road on the left. \_\_\_\_\_.
- 4 Oh, no, it isn't. It's in the road on the right. \_\_\_\_\_.
- 5 There it is, on your left. \_\_\_\_\_!

(5 marks)

**Part 2: Reading and writing**

**Reading**

Read the text and answer the questions.

**The new smartphone**

This smartphone is ultra slim and easy to use. There are lots of good things about the phone, but it also has some faults. It has face ID, a 12 megapixel camera, a camera that takes great videos and a lot of useful apps such as a calendar and a calculator. You can send pictures, sounds and text in your messages, but the phone has a low battery life. You can connect to the internet, but you can't play games on the phone. It has a radio but it doesn't have a good alarm. It has a beautiful cover. The cover is available in red, blue, green and white.

- 1 What is good about the smartphone? Name three things.  
\_\_\_\_\_
- 2 What useful apps does the phone have?  
\_\_\_\_\_
- 3 What can you send in your messages?  
\_\_\_\_\_
- 4 What is not good about the smartphone? Name three things.  
\_\_\_\_\_
- 5 Can you have a black cover?  
\_\_\_\_\_

(5 marks)

**Writing**

Write five sentences to explain what happens when you use these parts of a car. Begin each sentence with *When you* and add verbs and punctuation.

- the key – the engine start
- the accelerator pedal – the car
- the brake pedal – the car
- the steering wheel – left/right
- the engine – the car stops

- 1 \_\_\_\_\_
- 2 \_\_\_\_\_
- 3 \_\_\_\_\_
- 4 \_\_\_\_\_
- 5 \_\_\_\_\_

(5 marks)

## Contents

### 1 Heating system

#### Objectives

In this section, students will ...

- put heads on arrows to show the direction of flow in a solar heating system
- read a description of a solar heating system to check arrows
- identify the meaning of the reference words *it* and *here* in the text
- put events into the correct sequence in a flow chart
- study present simple singular with -s and -es endings and plurals
- label diagrams with prepositions of movement
- complete a table with verbs that are synonyms of phrasal verbs with *go*
- complete sentences with the correct form of verbs
- explain a diagram of a system to a partner
- write an explanation of the system

### 2 Electrical circuit

#### Objectives

In this section, students will ...

- label an electrical circuit using electrical symbols
- listen and label a diagram of a solar panel system
- listen and match items with their specifications
- in pairs, explain how the current flows in three situations using the diagram and draw arrows to show the flow
- read the manual to check answers to previous task
- study the zero conditional, positive and negative forms
- in pairs, explain how the controller works and make notes
- complete a text with the correct form of the verb

### 3 Cooling system

#### Objectives

In this section, students will ...

- do a quiz about normal or average temperatures for different things
- listen and check answers to the quiz
- label a diagram of a car cooling system
- read and check labels are correct in the diagram
- identify what the reference words *it*, *here* and *this* refer to in the text
- make true sentences about a cooling system
- in groups, discuss how a passive air cooling tower works
- complete a description of a passive air cooling tower
- listen and read a dialogue about an electronics student who works part-time in an electronics workshop
- practise the dialogue in pairs
- discuss their own weekly schedule

## Briefing

This unit deals with explaining how fluids move (or **flow**) around a system, and how electrical current moves around a circuit. A **fluid** can be a **liquid** (such as water) or a **gas** (such as air).

### 1 Heating system

Section 1 has a reading text that describes a solar water heating system (a **thermosiphon**), in which water flows through **pipes**, a **tank** and a **solar water panel**. The solar water panel is a flat water tank with a transparent front surface which allows the Sun's rays to heat the water. The **pressure** of the **mains water supply** (from outside the house) pushes the water up to the tank and then **around** the system. Once the water is in the tank (which must be *above* the water panel), gravity helps it to flow down into the water panel. The flow is controlled at the inlet and at the shower outlet by a **valve**. The water heating system on page 37 is similar to the thermosiphon on page 36. The only difference is that here the water tank is *below* the panel, and so a **pump** is needed to push water from the tank up to the panel.

### 2 Electrical circuit

Section 2 deals with the flow of **electric current** around a **circuit**. Current can only flow when there is a **closed** circuit between a **power source** (such as a **battery** or **mains electricity supply**) and an **appliance** (such as a **lamp**). When you **open** a **switch**, the circuit is broken, so the current cannot flow. When you **close** the switch, the current can flow. The **circuit diagram** at the top of page 38 shows some common elements of a circuit. The **solar panel** on page 38 is different from the solar *water* panel on page 36. The panel here contains **photovoltaic cells** which convert sunlight into electrical current. The current then flows through a **controller** and either into the battery or directly into the lamps. The controller detects when the battery is full or empty and checks if there is any current from the solar panel. It can direct the current from the panel either to the battery or straight to the lamps. When there is no current from the panel, it directs current from the battery to the lamps. When the lamps are not needed, it directs current from the panel into the battery. In the diagram of the controller on page 39, the current flows from the top of the panel along the red wire. The controller detects whether the battery is full or empty

(1) When it is full, the controller closes switch A. This **short-circuits** the panel, which means that the current simply flows through switch A and back into the panel, so no current can flow into the battery. Instead, current flows from the full battery through switch B (which is also closed) into the lamp. (2) When the battery is low or empty, the controller opens switch B (and switch A) so that no current can flow from the battery into the lamp. Instead, current flows from the panel into the battery.

### 3 Cooling system

Section 3 has a text on page 40 about a **car cooling system**. The diagram here is very schematic to make it as simple as possible. It does not show the **fan** or the **belt** which drives the **pump** which pushes the **coolant** around the engine. (For a more detailed diagram, use the search terms below to find useful websites.) The coolant is a liquid consisting of water and chemicals that prevent the water from freezing in cold weather and damaging the engine. The **thermostat** controls the temperature of the liquid (i.e. the coolant). When the engine is cold, the thermostat prevents the coolant from flowing through the **radiator**, which helps the engine to warm up quickly. When the engine is warm, the thermostat allows the coolant to flow.

The **passive air conditioning system** on page 41 operates without a power source (except for the pump). The air flows through the house by the simple principle that hot air rises and cool air sinks. This simple type of air cooling system is a traditional way of cooling houses in hot desert climates. Architects sometimes incorporate aspects of passive air conditioning when designing modern buildings.

#### Further reading online

Enter these search suggestions to find out more about the topics below:

**solar water heaters and passive air conditioning:**

*appropriate technology library solar devices*

**thermosiphons:** *how thermosiphon works*

**circuits:** *all about circuits vol 1*

**solar cell controller:** *basics solar power answers*

**water heaters:** *howstuffworks water heater*

**car cooling system:** *howstuffworks car cooling system*



## Teacher's notes

### 1 Heating system

#### Start here

- 1 Ask students to look at the diagram of the house. Point out the hot and cold water pipes and the various parts labelled. Pre-teach the word *flow*. Tell students that rivers flow from the mountains to the sea. Draw a simple diagram of this on the board.

Put students in small groups to discuss which way the water flows in the system. Tell them to draw arrows on the diagram to show the direction of the flow. Do not confirm answers at this stage.

#### Reading

- 2 Ask students to read the text and check the directions of the arrows they drew in 1.

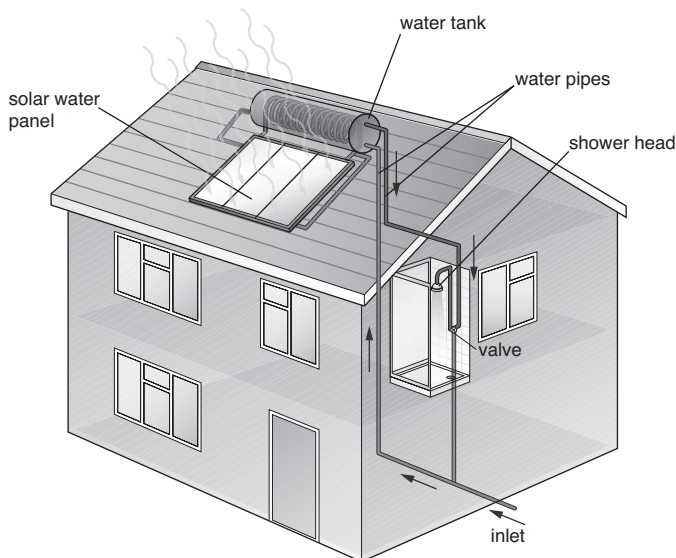

- 3 Ask students to look at the words circled in the text in 1 and go through the example with the class. Tell them that *it* refers to an object that is mentioned before in the text and *here* refers to a place. Point out that they should read the information in the sentences that comes before the words circled to help them find out what they refer to.

1 b 2 a 3 c 4 c

- 4 Ask students to look at the flow chart of the water system at the bottom of the page. Explain that the boxes are not in the correct order. Tell them to redraw the flow chart, putting the boxes in the correct order. They can then compare their flow charts with a partner before you check with the class.

#### START HERE

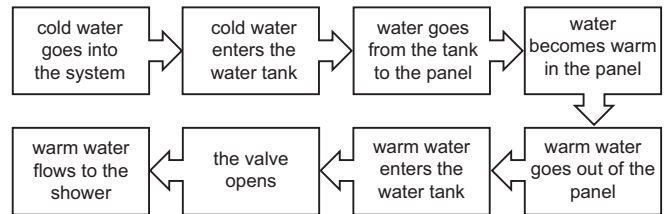

## Language

### Present simple

Go through the language box with the students. Here students are presented with the present simple used to talk about facts. Remind them that you normally add an -s to the infinitive in the third person singular. Then point out the irregular spelling for *go* – *goes*, and *pass* – *passes*. Explain the spelling rule that with verbs ending in -o, -ss, -sh and -ch, you add -es.

Tell students that they'll find more information about forming the present simple in the *Grammar summary* on pages 100–101 of the Course Book.

### Vocabulary

- 5 Ask students to look at the diagrams and label them with the prepositions in the box.

1 into 2 out of 3 to 4 from 5 through 6 around

- 6 Students complete the table with the verbs in the box. Tell students to refer back to the diagram and text in 1 to help them.

1 rise 2 sink 3 enter 4 leave

- 7 Ask students to complete the sentences using the verbs from the table in 6 in the correct form.

1 enters 2 leaves 3 rises 4 sinks

### Task

- 8 Put students in pairs. Ask Student A to turn to page 114. Ask students to read the instructions. Tell Student B to listen carefully while their partner explains their system. Tell them to ask questions to make sure they understand how the system works and to draw a simple diagram of the system. They then swap roles. Finally, ask students to check their drawings with their partner and to correct them if necessary.

## Writing

- 9 Students write an explanation of the system they described to their partner in 8.

If you think your students will need extra support in writing an explanation of their systems, write the following on the board as prompts.

- *The main parts of the ... are ... and ...*
- *The pump is (above/below) the ...*
- *The cold water (enter/leave) the ... through the ...*
- *Inside the ..., the ... (heat/cool) the ...*
- *The ... (push/pull) the water to the ...*
- *The (hot/cold) water (rise/sink) to the (top/bottom) of the ...*
- *The hot water (enter/leave) the ... through the ...*

Students could do this writing activity in class or for homework.

## 2 Electrical circuit

### Start here

- 1 Students could work in pairs or on their own to label the symbols in the circuit diagram with the words in the box. When they've finished, they can then check their answers on page 109 in the *Reference* section.

Write *conductor*, *terminal*, *negative* and *positive* on the board, underlining the stress in the words. Ask students to repeat the words after you. Remind them that you don't pronounce the *e* in *battery*.

1 lamp 2 conductor 3 negative 4 battery  
5 positive 6 switch 7 terminal 8 fuse

### Listening

#### 2 5.1

Students could label the diagram with the words in the box first. Then play the recording for students to listen and check.

1 solar panel 2 controller 3 cables 4 lamps  
5 battery

#### 5.1

[L = Lecturer; S = Student]

**L:** Right. Now let's look at this diagram of the circuit, up here. Can you see it clearly? On the left, here, you can see a solar panel. OK? The solar panel collects the sunlight and changes it into electricity. And here, on the right, you can see three lamps. These three long things. OK? And there, between the panel and the lamps, you can see a controller and a battery.

**S:** Excuse me. Which one is the controller?

**L:** Well, the controller's at the top, OK? And, of course, the battery's at the bottom, here, below the controller. And finally, you can see some electrical cables or wires. The cables run from the panel, through the controller, into the battery, and also into the lamps.

#### 3 5.2

Remind students that they studied abbreviations for electricity in Unit 1. Ask students to tell you what *V*, *W* and *A* mean, and if they can tell you what *DC* (*direct current*) and *Ah* (*Ampere hour(s)*) mean. Remind them that there is a list of abbreviations on page 106 in the *Reference* section.

Play the recording for students to listen and match the items with their specifications.

1 d 2 c 3 e 4 a 5 b

#### 5.2

[L = Lecturer; S = Student]

**L:** OK? So, to summarise, here again, these are the main parts of the system. A sixty watt solar panel; ... a five amp controller; ... a twelve volt one hundred ampere hours battery; ... and three twelve volt eight watt lamps.

**S:** Excuse me, what kind of electrical current is it?

**L:** It's a direct current – DC. Is that clear now?

### Task

- 4 Put students in pairs and ask them to look back at the diagram in 2. Tell them to draw arrows on the diagram to show the current flow in the three different situations. Do not confirm answers at this stage.

- 5 Ask students to look at the note in the margin before they read the manual for the solar power systems. Then ask them to check their answers to 4.

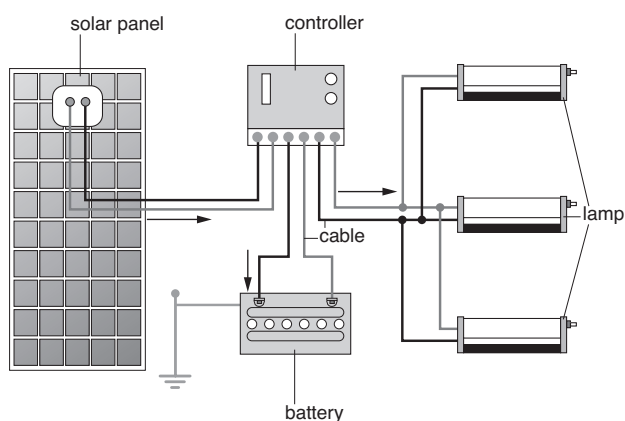

## Task

- 6 Put students in pairs and ask them to look at the diagram of the controller at the bottom of the page. Students discuss how it works and make notes. Do not confirm answers at this stage.
- 7 Tell students to read the text explaining how the controller works and to complete it choosing the correct verb in the brackets in the correct form. They can then compare the text with the notes they made in 6.

1 closes 2 doesn't flow 3 opens 4 doesn't flow

## Language

### Zero conditional

Go through the language box with the class. Here students are presented with the zero conditional. Explain that you use the zero conditional to talk about something that is always true. You use the present simple in the conditional clause and also in the result clause. Write the following example on the board:

(conditional clause) (result clause)

*If the Sun **shines**, the current **flows** from the panel.*

Tell students that you always use a comma after the conditional clause. (Note that you can put the result clause first, and in this instance you don't use a comma. You could also use *when* instead of *if* in these sentences.)

Tell students that they'll find more information showing all forms of the zero conditional in the *Grammar summary* on page 104 of the Course Book.

### Extra activity

Write these sentences on the board and ask students to complete them:

- 1 If the Sun shines, and the lamps are on, ...  
(current / flow / panel / lamps)
- 2 If the Sun doesn't shine, and the lamps are off, ...  
(current / flow / panel)
- 3 If the battery is full, ... (current / not / flow / panel / battery)

### 3 Cooling system

#### Warmer

You could quickly revise numbers here. Write the following numbers on the board:

183, 157, 147, 50, 30, 15, 13, 0, 2.5, 3.75

Then write a couple of sums on the board:

$30 + 157 =$        $2.5 - 15 =$

Ask *What's thirty plus one hundred and fifty-seven?* and elicit the answer (= 187). Then ask: *What's two point five minus fifteen?* (= -12.5). Ask students to write five sums for their partner, using the numbers on the board in any combination. Tell them to also make note of the answer. They dictate the sum to their partner who writes it down and then checks the answer with their partner. Go round the class as they're doing this making sure that they're saying the numbers correctly.

#### Start here

- 1 Before students start the quiz, ask them to read the note in the margin about Fahrenheit and Celsius. Point out that most countries use Celsius (= centigrade). However, some countries, including the US, use Fahrenheit.

Students do the quiz about the normal temperatures for things. They then compare their answers with a partner. Do not confirm answers at this stage.

#### Listening

#### 2 5.3

Play the recording for students to check their answers to 1. Then check with the class by asking individual students to read out the answers. Make sure that they are pronouncing the temperatures correctly.

1 a 2 b 3 b 4 a 5 b 6 a

#### 5.3

- 1 **A:** Turn down that thermostat, please. The water's too hot for a shower. The correct temperature is about 40 degrees.  
**B:** Fahrenheit?  
**A:** No, Celsius, of course.
- 2 **A:** This refrigerator is too cold. Turn the temperature up to about 4.5 degrees.  
**B:** Fahrenheit?  
**A:** No. That's too cold. 4.5 degrees Celsius.
- 3 **A:** That freezer's too warm. Turn the temperature down to zero degrees.  
**B:** Zero degrees Celsius?  
**A:** No, that's too warm. Zero degrees Fahrenheit. That's the same as minus eighteen degrees Celsius.
- 4 **A:** Do you know the record for the coldest air temperature in the world?  
**B:** No.  
**A:** It's minus 89 degrees.  
**B:** Fahrenheit?

**A:** No, Celsius.

**B:** Where is it?

**A:** In Antarctica.

- 5 **A:** And the hottest temperature in the world. Do you know that?

**B:** No.

**A:** It's 136 degrees.

**B:** Celsius?

**A:** No, no. Fahrenheit.

**B:** Where is it?

**A:** In Libya.

- 6 **A:** The car engine is too hot.

**B:** Why? What's the correct temperature?

**A:** About 100 degrees.

**B:** Is that Fahrenheit?

**A:** No, Celsius.

#### Reading

- 3 Ask students to look at the diagram of the car cooling system and to label it with the words in the box. Do not confirm their answers at this stage.
- 4 Ask students to read the text and check their answers to 3. When checking students' answers, make sure that they're pronouncing the words correctly and that they're putting the correct stress on *radiator* and *thermostat*, and are pronouncing the /dʒ/ sound in *engine*.

1 engine 2 thermostat 3 top hose 4 radiator  
5 bottom hose 6 pump

- 5 Ask students to look at the words circled in the text in 3. and go through the example with the class. Point out that *This* refers to an object that is mentioned before in the text. Tell them that they should read the information in the sentences that come before the words circled to help them find out what they refer to.

1 b 2 c 3 b 4 a

#### Speaking

- 6 Ask students to make true sentences from the words in each column. Pre-teach the word *blow*. You could then do an example with the class to make sure that they know what to do. Then tell them to check their answers by looking back at the text in 3.

- 1 The pump pushes liquid around the engine.  
2 The thermostat controls the temperature of the liquid.  
3 The two hoses connect the radiator to the engine.  
4 The radiator cools the hot liquid from the engine.  
5 The fan blades blow air onto the radiator.  
6 Cool liquid sinks to the bottom of the radiator.  
7 Hot liquid rises to the top of the engine.  
8 Liquid flows through the two hoses.

## Task

- 7 Ask students to look at the diagram of the cooling system, and briefly discuss how some architects are inspired by the traditional technology of the cooling tower to create sustainable cooling systems in modern buildings. Ask students to look carefully at the direction of the flow in the stages 1–11. Then put students in small groups to discuss how the cooling system works and what happens at each of the stages. Go round the class monitoring and helping with any language problems.

## Writing

- 8 Ask students to look at the text explaining how the cooling system works and tell them that the bracketed numbers refer to each of the stages (1–11) in the diagram in 7. Go through the first two stages in the text with students so that they know what to do. Then ask them to complete the rest of the text with the verbs and prepositions in the box. Remind them to look back at the diagram to help them with each stage.

|                   |                      |
|-------------------|----------------------|
| 1 through; to     | 7 flows around       |
| 2 leaves; through | 8 flows out of; into |
| 3 enters; through | 9 heats              |
| 4 cools           | 10 rises             |
| 5 sinks           | 11 leaves; through   |
| 6 enters          |                      |

## Social English

### 9 5.4

Ask students to read the introduction to the recording. Then play the recording while students read the dialogue. Tell students to read the note in the margin and remind them that you pronounce *do you* /dʒ/ in present simple *Wh*- questions. You could play the recording again, and pause after the questions for students to repeat them.

### 5.4

[D = Dan; J = Jack]

**D:** I work in the electronics workshop every Thursday and Friday.

**J:** When do you attend lectures?

**D:** Every Tuesday morning.

**J:** What do you do on Tuesday afternoons?

**D:** I do my practical work then.

- 10 Put students in pairs to practise the dialogue.

- 11 Put students in pairs to discuss their own weekly schedules. Go round the class listening to their discussions and helping them with any problems.

### Extra activity

For students who are having problems with this teaching point, you could give them some extra practice by putting the following on the board. They can then practise similar dialogues to the one in the book.

|     | Morning                      | Lunch time              | Afternoon         | Evening               |
|-----|------------------------------|-------------------------|-------------------|-----------------------|
| MON | Work in lab                  | Practise football       | Study in library  | Write lab reports     |
| TUE | Attend lectures              | Play guitar with group  | Do practical work | Read course books     |
| WED | Meet tutor                   | Have lunch with friends | Prepare projects  | Watch film at college |
| THU | Work in electronics workshop |                         |                   | Learn English         |
| FRI | Work in electronics workshop |                         |                   | Go out with friends   |

## Contents

### 1 Materials testing

#### Objectives

In this section, students will ...

- in pairs, discuss the materials used for the helmet and rope in a photo and design a test for the material
- listen to a tutor testing a material and answer the questions
- listen again and complete the dialogue in the present continuous
- study the present continuous
- match verbs used in testing materials with pictures
- complete the description to test materials using the present continuous
- describe all the actions of people exercising in a gym, using the present continuous
- ask and answer questions in pairs about the actions in the picture of the gym
- guess a sport from their partner's mime

### 2 Properties

#### Objectives

In this section, students will ...

- discuss the properties of materials in pairs
- match photos of things with the material they're made of
- underline the stressed syllables in names of materials
- listen and check answers and practise using the correct stress in names of materials
- study forming questions and answers using *made of*
- listen to and repeat a dialogue about materials using *made of*
- practise making questions and answers using *made of*
- match the description of materials with its property
- match property adjectives with opposites
- read a text about racing car parts, materials and properties and complete a table

### 3 Buying

#### Objectives

In this section, students will ...

- listen to a voicemail message and complete a form with name, phone number, email address and message
- listen and write the correct email and web addresses
- dictate email and web addresses to a partner
- listen to a phone conversation and complete the questions
- roleplay a phone call in pairs
- roleplay a conversation between a customer and sales person about buying equipment over the phone
- listen to three phone calls which show different ways of starting a phone call
- practise short phone calls in pairs

## Briefing

This unit deals with ways of communicating about materials, their properties and how to test them. This is relevant to a range of industries including chemical engineering, plastics processing, mechanical and automobile engineering, aerospace, building and construction.

### 1 Materials testing

Section 1 introduces the names of actions which are carried out when testing materials for their strength or resistance to different forces. The surface of a **hard** material resists cuts and scratches, so you would test **hardness** (and its opposite, **softness**) by trying to **scratch** it. A **tough** material doesn't break easily when you **strike** it or **drop** it from a height; a **brittle** material breaks easily. Some materials have **compressive strength** (see Book 2): they don't **deform** (change shape) or break when you **compress** (squeeze) them. Materials with **tensile strength** (see Book 2) don't deform or break when you **stretch** them (pull them apart). Materials with both tensile and compressive strength don't deform or break when you **bend** them: they are **rigid**; if they bend slightly but do not break they are **flexible**. **Heat-resistant** materials resist **heat**: they don't deform or burn when you heat them, and **corrosion-resistant** materials don't **corrode** when they are exposed to moisture or chemicals.

### 2 Properties

Section 2 introduces some common industrial materials and their properties. The **property** of a material is its characteristic feature, or special strength. For example, one property of rubber is that it does not conduct electricity. **Natural** (or **organic**) materials include **wood** and **rubber**. A **ceramic** is a material produced by grinding rocks to powder and then heating it to a high temperature. Many ceramics are very hard, tough and heat-resistant. **Plastics** (also called **polymers**) have many different properties: **polystyrene**, in a plastic foam form called EPS (expanded polystyrene) is a rigid and lightweight plastic used in packaging of electrical goods because it can resist impact and changes of temperature; **polycarbonate** is a strong, stiff, hard, tough, transparent plastic, used for instance in the lenses of sunglasses; **nylon** is a tough plastic with good thermal and chemical resistance; it can also be processed into a **fibre** (or thread) with good tensile strength which can be used for making climbing ropes. A **composite** is a strong material made by mixing a polymer with a ceramic or natural material: **fibreglass** and **graphite** are composites. **Metals** and **alloys** (mixtures of two or more metals) are common engineering materials: **aluminium** and **titanium** are examples of pure metals; **steel** and **cromoly** are alloys. Titanium is used in many

industrial, aerospace and marine applications: it is as strong as steel, but about half as dense, which makes it much lighter. It is also corrosion-resistant. Aluminium is even lighter, only one-third the density of steel. Cromoly (chromium-molybdenum steel) is a steel alloy: it is **weldable** (can be **welded**), **formable** (can be shaped), strong, **ductile** (can be made into a thin wire) and tough. It is used in making bicycle frames. The reading text on page 45 has examples of *made of* (when the object is composed of one material) and *made from* (when the object is composed of a combination of different materials). This distinction is worth pointing out to students, although it is not taught specifically in this book, since it is not a consistent rule. It is sometimes possible to use *made of* and *made from* interchangeably for both meanings.

### 3 Buying

Section 3 gives practice in using the phone when buying and selling goods, particularly when giving (or listening to) details such as names, phone numbers, product numbers, email addresses and web pages. In 4 on page 46, students are helped to distinguish between numbers ending in *-teen* and *-ty*, which are easily confused. (The advice is to put syllable stress on *-teen* but never on *-ty*.) There is also practice in asking someone to *repeat* or *spell* a word that may have been misheard, and then to check that you have heard it correctly.

#### Further reading online

Enter these search suggestions to find out more about the topics below:

**plastics:** *bpf introduction plastics*

**properties of plastics:** *resistant materials plastics properties bbc bitesize*

**properties of metals and alloys:** *resistant materials metals alloys properties bbc bitesize*

**composites:** *ceramics polymers composites bbc bitesize*



## Teacher's notes

### 1 Materials testing

#### Warmer

Write *wood, metal and glass* on the board and point at some objects in the class and ask: *What's it made of?*

#### Start here

- 1 Ask students to look at the photo of the mountaineer. Ask what they can see in the picture. Ask: *What's the man wearing on his head? (a helmet)* and *What's he using to pull himself up the mountain? (a rope)*.

Put students in pairs. Focus their attention on the helmet and rope and ask them to answer the first question. Tell them they'll find the name of the materials they're made of in the box.

Then ask them to design tests for the helmet and rope for mountain climbing, using the words in the box. Tell them to draw diagrams to illustrate their test. They can then compare their tests with another pair.

#### Listening

### 2 6.1

Tell students that they're going to listen to a lecture about testing the strength of mountaineering rope. Ask them to read the three questions first. Then play the recording for them to answer the questions.

- 1 Nylon.
- 2 He's pulling the rope and he's stretching it.
- 3 No, it isn't.

### 6.1

[L = Lecturer; T = Trainees]

**L:** Today, we're doing a tensile strength test for this mountaineering rope. OK. Is everyone ready? Can you see and hear me clearly?

**T:** Yes.

**L:** All right, now listen and watch carefully. The rope is made of nylon. Now I'm pulling the rope. I'm stretching it. Is it breaking?

**T:** No, it isn't.

**L:** That's right. It isn't breaking.

- 3 Ask students to look at the dialogue between the lecturer and the trainees. They listen to the recording again and complete the dialogue. Then ask students to compare their answers with a partner before you check with the class.

- 1 pulling
- 2 stretching
- 3 breaking
- 4 isn't
- 5 isn't breaking

## Language

### Present continuous

Go through the language box with students. Explain that the present continuous tense is used to describe what's happening at the time of speaking. You form the present continuous with the verb *be* and the present participle. Point out the contractions for *I am – I'm* and *is not – isn't*, and remind them to use these contracted forms when speaking.

Students will need to be aware of the spelling rules when changing the infinitive to the *-ing* form:

You normally simply add *-ing* to the verb, e.g. *break – breaking, pull – pulling*.

For verbs ending in *-e*, you drop the *-e* and add *-ing*, e.g. *strike – striking*.

For verbs ending in a vowel then a consonant, you double the consonant and add *-ing*, e.g. *cut – cutting, drop – dropping*.

Point out that the auxiliary *be* comes before the subject in questions, ***Is the rope breaking?*** and that you use the same auxiliary in the short answer: ***No, it isn't.***

Tell students that they'll find more information showing all forms of the present continuous in the *Grammar summary* on page 102 of the Course Book.

### Vocabulary

- 4 Ask students to look at the pictures of the different actions and match them with the verbs in the box.

- 1 scratch
- 2 compress
- 3 stretch
- 4 bend
- 5 strike
- 6 drop
- 7 cut
- 8 heat

## Language

- 5 Tell students that in the following text the lecturer is giving a description about testing other materials. Pre-teach *melt* by asking what happens to ice when you heat it. Then ask students to complete the lecturer's description, using the words in brackets in the present continuous tense. Refer them to the note in the margin to remind them of the spelling rules in the present continuous. Finally, when you go through students' answers, make sure that you check their spelling.

- 1 'm heating
- 2 isn't melting
- 3 'm putting
- 4 is dropping
- 5 's striking
- 6 isn't bending
- 7 are compressing
- 8 isn't breaking
- 9 is hanging
- 10 aren't stretching

## Speaking

- 6 Ask students to look at the picture of the gym and ask them to describe what the people in the gym are doing using the words in the box.

*Example answers:*

- A She's sitting on an exercise bike. She's cycling.
- B He's running.
- C She's pushing the pedals on the machine.
- D He's pushing the bar up. (or He's pulling the bar down.)
- E He's touching his toes.
- F and G They're holding/lifting weights.
- H He's sitting on the floor. He's stretching his leg.

### Extra activity

Ask students to change the spelling of the verbs in the box from the infinitive into present participles, e.g. *bend* – *bending*.

- 7 Students can either ask and answer questions about the picture in 6 across the classroom, choosing another student to answer their question, or you can put students in pairs to do the exercise.

Point out that when they ask the question, the information in the question should be incorrect so that the student they are asking can correct it.

You could then ask students if they go to the gym and to tell their partner what exercises they do there.

- 8 Put students in pairs. Read through the example with a student first, taking the part of A, so that they know what to do. Mime the action of swimming as you read the first line of the dialogue. Go on to mime another sport and ask a student to guess what it is. Then put students in pairs to take turns to mime a sport and to guess what the sport is.

## 2 Properties

### Warmer

Students work in pairs. They revise some of the vocabulary from the previous lesson by instructing the class to do some actions, using the verbs from that lesson e.g. *stretch your leg, touch your toes, bend your elbow, hold your book above your head*, etc.

### Start here

- 1 Put students in pairs. Ask them to look at the names of the materials in the box and discuss the question with their partner. Tell them to use the words in the example answer to help them to describe the properties of the materials.

### Vocabulary

- 2 Ask students to look at the photos. Students don't have to know the names of the items in this exercise, as they only need to identify the materials the items are made of. They match the items with the materials in the box. Students can then compare their answers with a partner before you check with the class.

1 ceramic 2 polycarbonate 3 polystyrene  
4 fibreglass 5 graphite 6 titanium 7 rubber  
8 nylon 9 aluminium 10 steel

### Speaking

- 3 Explain to students that the words have been broken up to show where the syllables come in the words (except for steel, which is monosyllabic). Remind students that English is a stressed-timed language and that it's important to stress the correct syllable in words to be understood. Ask students to underline the stressed syllable for each word. Tell them to say the words out loud as this may help them to choose the correct syllable to underline. Do not confirm answers at this stage.

### 4 6.2

Play the recording for students to check their answers to 3. Then play it again for students to repeat the words. Make sure that they're using the correct stress. Finally, point out the British English and American English spellings in the box in the margin.

1 nylon 2 graphite 3 ceramic 4 polycarbonate  
5 aluminium 6 polystyrene 7 titanium  
8 fibreglass

### 6.2

1 nylon  
2 graphite  
3 ceramic  
4 polycarbonate  
5 aluminium  
6 polystyrene  
7 titanium  
8 fibreglass

## Language

### What's ... made of? It's made of ...

Go through the language box with students. Remind students that you use the verb *be + made of* to ask and talk about the material of things, e.g. *What's the helmet on page 42 made of?*

### 5 6.3

Play the recording once through for students to listen and read the dialogue.

Tell students to underline the stressed syllables in *ceramic* and *polycarbonate*. Point out that *of* is pronounced /əv/ in a sentence and is not stressed. Then play the recording again, pausing after each sentence for students to listen and repeat.

### 6.3

A: What's this made of?  
B: It's made of ceramic.  
A: What are these made of?  
B: They're made of polycarbonate.

- 6 Put students in pairs. Ask them to take turns to choose photos from 2 and make similar dialogues to the one in 5. Tell students to point to the photos in 2 when asking the question.

### Extra activity

Students work in pairs. They describe a couple of objects they have and talk about what they are made of. Tell them to look up the word for any materials they don't know in their dictionaries.

## Vocabulary

- 7 Ask students to match the sentences. They can check their answers with a partner before you check with the class.

1 d 2 c 3 a 4 e 5 b

- 8 Students match the adjectives 1–5 with their opposite adjectives a–e.

Then ask students to repeat the adjectives after you, making sure that they're pronouncing the *gh* in *tough* with an /f/ sound – /tʌf/, and pronouncing the *g* in *rigid* with a /dʒ/ sound – /rɪdʒɪd/.

1 d 2 a 3 e 4 c 5 b

### Extra activity

Ask students to look back at the photos in 2. They choose one of the objects and describe the material it's made of using the words from 7 and 8. Their partner guesses the object they're describing.

## Reading

- 9 Ask students to look at the photo of the Formula One car and the diagram. Point out the wings and spoiler in the inset diagram. Pre-teach some of the vocabulary from the text: point out the nose cone, wheels, tyres, and frame for them on the photo and pre-teach the word *piston* if students don't know it. Then go through the notes in the margin below, next to the table.

Ask students to read the text and complete the table below it. They can then check their answers with a partner before you check with the class.

Point out that adjectives are used in front of nouns, e.g. *The nose cone of the vehicle is made of strong, light fibreglass.* When adjectives are in a sentence with the verb *be*, they go after the noun, e.g. *Many of the materials in the car are light, but very strong.*

- 1 fibreglass
- 2 strong, light
- 3 fibreglass
- 4 hard
- 5 aluminium
- 6 strong, light
- 7 rubber
- 8 tough
- 9 ceramic
- 10 heat-resistant
- 11 cromoly
- 12 light, tough and rigid
- 13 aluminium (coated with ceramic)
- 14 corrosion-resistant

### Extra activity

Students could write a short text about something they own, describing what materials it's made of and what the properties of the materials are. Remind them to put the adjectives before the noun, except when they're using the verb *be*.

### 3 Buying

#### Warmer

Go through some vocabulary used in email and web addresses. Make sure that students know what *dot*, *dash*, *underscore* and *slash* are. You could get them to do the following matching activity.

- |                          |           |
|--------------------------|-----------|
| 1 go dot fly             | a) go-fly |
| 2 go dash fly            | b) go_fly |
| 3 go underscore fly      | c) go/fly |
| 4 at go fly all one word | d) go.fly |
| 5 go forward slash fly   | e) @gofly |

#### Listening

##### 1 6.4

Tell students that they're going to listen to a voicemail message. Ask students to look at the form first so that they know what information they need to listen for. Play the recording for students to complete the form. Play it a second time pausing after each piece of information to give students time to write it down. They can then check their answers with a partner before you play it a final time.

Name: Manuel Vargas  
Phone number: 00 34 9466 389  
Email address: mvargas17@xtreme\_sports.co.es  
Message: (Please send) catalogue of sports equipment

##### 6.4

Hello, This is Manuel Vargas. That's V-A-R-G-A-S. My phone number is double oh, 34 94 double 6 389. I'll repeat that: double oh, 34 94 double 6 389. Please send me your catalogue of sports equipment. My email address is mvargas17@xtreme\_sports.co.es. I'll say that again, mvargas17 that's M-V-A-R-G-A-S seventeen all one word ... at ... xtreme underscore sports, that's spelt X-T-R-E-M-E underscore S-P-O-R-T-S dot co dot E-S.

##### 2 6.5

Ask students to look at the example in the table. Tell them they will hear the email and web addresses being read out and that they need to note down the written form for the addresses. Play the recording. After each address, pause the recording for students to write the address down. They can then check their answers with a partner. Then play the recording a final time.

- waleed@sports.com
- adam@city.co.uk
- theadenton@goaldust.com
- c.rolands@back-of-the.net

##### 6.5

- waleed at sports dot com
- adam at city dot co dot UK
- thea denton, that's T-H-E-A then D-E-N-T-O-N at goaldust, that's G-O-A-L-D-U-S-T, all one word dot com
- C dot rolands, that's R-O-L-A-N-D-S at back-of-the-net, that's B-A-C-K dash O-F dash T-H-E dot net

#### Speaking

- Put students in pairs. Ask Student A to turn to page 114 and Student B to turn to page 118. They create four email and web page addresses from the different components and then take it in turns to dictate their addresses to their partner. They then check their partner's answers.

#### Listening

##### 4 6.6

Tell students that they're going to listen to a phone conversation in which one of the speakers is taking down the other person's details. Play the recording for students to complete the questions. Refer students to the note in the margin to remind them how to pronounce numbers ending in *-ty* and *-teen*.

- 1 repeat   2 spell   3 Is that   4 Is that

##### 6.6

- A: What's your surname, please?  
B: It's Lint.  
A: Could you repeat that, please?  
B: Lint.  
A: Could you spell that, please?  
B: L-I-N-T.  
A: Is that T or D?  
B: It's T. T for teacher.  
A: Thanks. And what's the product number?  
B: It's seventeen dash three oh five.  
A: Is that 17 or 70?  
B: Teen. Seventeen. One seven.  
A: Right. Thanks.

#### Speaking

- Students now practise the phone call with a partner. They take it in turns to be the caller and the person taking down the caller's details.

## Task

- 6** Put students in pairs. Ask Student A to turn to page 116. Ask students to look at the website and read the instructions. Students then take it in turns to phone up each other to order the items. Refer students to the useful language box in the margin to help them ask questions. Tell students to make notes of the order on the order form and then to check they have the correct information on the form with their partner when they've finished.

## Social English

### 7

Put students in pairs. Ask students to look at the dialogues numbered 1, 2 and 3. Explain that Mike is phoning his friend John and that these are three different versions of the same telephone call. Play the recording for students and ask them to read the conversations at the same time.

Point out some useful language for answering the phone. Ask them to look at the three columns and tell them to:

- 1 find the most formal way to answer the phone. (*Hello. John Davis here.*)
- 2 find the phrase you use when you want to speak to someone on the phone. (*Is that John?*)
- 3 find three phrases you can use to tell someone who you are on the phone. (*It's Mike. It's me. This is Mike.*)
- 4 find two phrases to greet someone. (*How are you? How are things?*)

Then ask students how you can reply to these greetings. (*OK, thanks. Fine, thanks. Great, thanks.*)

### 6.7

[J = John; M = Mike]

- 1** **J:** Hello?  
**M:** Hello. Is that John?  
**J:** Yes?  
**M:** It's Mike.  
**J:** Oh hi, Mike.  
**M:** Hi. How are you?  
**J:** OK, thanks. How are you?  
**M:** Fine. I want to ask you ...
- 2** **J:** Hello?  
**M:** Hello. Is that John?  
**J:** Yes. Is that Mike?  
**M:** Yes, it's me. Hi. How are you?  
**J:** Fine, thanks. How about you?  
**M:** I'm fine. Would you like to ...
- 3** **J:** Hello. John Davis here.  
**M:** Oh hi, John. This is Mike.  
**J:** Hi, Mike.  
**M:** Hi. How are things?  
**J:** Great, thanks. How are you?  
**M:** Good. I'm phoning you to ...

- 8** Put students in pairs and ask them to use their own names and practise the phone calls, taking it in turns to play the part of the person phoning their friend and the friend.

# Review Unit C

## Answer key

- 1**
- 1 Grip the nail. Use a pair of pliers.
  - 2 Pull out the nail.
  - 3 Drive in the nail. Use a hammer.
  - 4 Loosen the bolt. Use a spanner.
  - 5 Tighten the bolt.
  - 6 Measure the wood. Use a tape measure.
  - 7 Cut the wood. Use a saw.
  - 8 Put on the goggles.
  - 9 Put the bar in the vice.
  - 10 Strike the bar in the vice. Use a hammer.
  - 11 Bend the bar in the vice.
  - 12 Take the bar out of the vice.
  - 13 Take off the goggles.
  - 14 Open the box.
  - 15 Put the goggles in the box.
  - 16 Close the box.
- 2**
- 1 He's gripping the nail. He's using a pair of pliers.
  - 2 He's pulling out the nail. He's using a pair of pliers.
  - 3 He's driving in the nail. He's using a hammer.
  - 4 He's loosening the bolt. He's using a spanner.
  - 5 He's tightening the bolt. He's using a spanner.
  - 6 He's measuring the wood. He's using a tape measure.
  - 7 He's cutting the wood. He's using a saw.
  - 8 He's putting on the goggles.
  - 9 He's putting the bar in the vice.
  - 10 He's striking the bar in the vice. He's using a hammer.
  - 11 He's bending the bar in the vice.
  - 12 He's taking the bar out of the vice.
  - 13 He's taking off the goggles.
  - 14 He's opening the box.
  - 15 He's putting the goggles in the box.
  - 16 He's closing the box.

- 3**
- 1 Water doesn't boil at 32 °F. It freezes.
  - 2 Hot water doesn't sink to the bottom of a tank. It rises to the top.
  - 3 Cool air doesn't rise to the top of a room. It sinks.
  - 4 Hot air doesn't sink to the bottom of a room. It stays at the top.
  - 5 The Sun's rays don't cool the water in the solar panel. They heat it.
- 4**
- 1 work 2 enters 3 pushes 4 does 5 become
  - 6 flows 7 heat 8 rises 9 passes 10 Does 11 have
  - 12 doesn't 13 stays 14 open 15 flows
- 5**
- 1 solar panel 2 pump 3 fan 4 thermostat
- 6**
- 1 'm pressing; isn't going
  - 2 's pulling; aren't rising
  - 3 're pushing down; isn't slowing
  - 4 'm sliding; aren't tilting
  - 5 's pulling; isn't reversing
  - 6 're moving; isn't going

7 **1** break **2** bend **3** doesn't break easily  
**4** can break it easily **5** bend easily

8 rise ≠ sink push ≠ pull  
enter ≠ leave open ≠ close  
into ≠ out of tough ≠ brittle  
heavy ≠ light hard ≠ soft  
strong ≠ weak to ≠ from  
go in ≠ go out flexible ≠ rigid  
inlet ≠ outlet go down ≠ go up

9 **1** boils **2** freezes **3** rises **4** sinks **5** melt  
**6** stretches

10 **1** polycarbonate **2** rubber **3** ceramic **4** aluminium

12 **1** strikes **6** are pulling  
**2** pull **7** isn't stretching  
**3** presses **8** is pressing  
**4** scratch **9** isn't breaking  
**5** is striking **10** are scratching

### Projects

**13 & 14** At the end of every Review Unit is a project. Students can use a good dictionary or an internet search engine.

Tip: to find the meaning of a word in Google, type *definition* and then the word.

sol- = Sun; solar = connected with the Sun  
poly- = more than one; polytechnic = a college that offers a variety of courses

## Quick test answer key

### Part 1: Vocabulary and grammar

1 **1** through **2** from, to **3** around **4** out of

2 **1** light **4** tough, flexible  
**2** heat-resistant **5** rigid  
**3** hard, corrosion-resistant **6** strong

3 **a** 3 **b** 4 **c** 2 **d** 6 **e** 1 **f** 5

4 **1** enters **2** rises **3** controls **4** heats **5** cools **6** flows

5 **1** If the Sun shines, the current flows into the lamps.  
**2** If you stretch this nylon rope, it doesn't break.  
**3** If the water is cold, it sinks to the bottom.  
**4** If you heat the ceramic, it doesn't burn.  
**5** If the ice melts, the water rises.

6 **1** 're driving **4** **A:** are, doing  
**2** isn't sitting **B:** 'm diving  
**3** 'm dropping, isn't breaking

7 **1** e **2** f **3** b **4** c **5** d **6** a

### Part 2: Reading and writing

#### Reading

**1** Carbon fibre composite. It's made of 50 percent carbon fibre composite and 20 percent aluminium.  
**2** It's light, strong and corrosion-resistant.  
**3** The fuselage and the wings.  
**4** The wings.  
**5** They have a 'raked' wingtip – a wing that bends up at the end.

#### Writing

##### Sample answer

The automatic fire sprinkler system controls and puts out fires. The main parts are pipes with a sprinkler head and a fusible link (a heat-sensitive element). The pipes contain water under pressure. The location of the system is in the walls and ceilings of the buildings.

How it works: When the temperature reaches 68 °C, the fusible link melts and the sprinkler opens. Water flows from the pipes to the sprinkler head and then it flows out of the sprinkler head.



# Review Unit C | Quick test

Total \_\_\_\_\_/50

## Part 1: Vocabulary and grammar

### 1 Underline the correct words.

- 1 Cold water enters the system (1) *through* / *up* the inlet.
- 2 Hot water flows (2) *from* / *in* the tank (3) *to* / *up* the shower head.
- 3 The pump pushes water (4) *around* / *to* the engine.
- 4 The hot air goes (5) *into* / *out* of the chimney and leaves the house.

(5 marks)

### 2 Describe the properties of these materials.

- 1 Polystyrene is *l*\_\_\_\_\_.
- 2 Ceramic is *h*\_\_\_\_\_ *-r*\_\_\_\_\_.
- 3 Titanium is *h*\_\_\_\_\_ and *c*\_\_\_\_\_ *-r*\_\_\_\_\_.
- 4 Rubber is *t*\_\_\_\_\_ and *f*\_\_\_\_\_.
- 5 Concrete is *r*\_\_\_\_\_.
- 6 Nylon is *s*\_\_\_\_\_.

(6 marks)

### 3 Match the sentences in 2 with the sentences a-f below.

- a) It doesn't corrode easily. \_\_\_\_\_
- b) You can stretch it. \_\_\_\_\_
- c) It doesn't burn. \_\_\_\_\_
- d) It doesn't break easily. \_\_\_\_\_
- e) It isn't heavy. \_\_\_\_\_
- f) You can't bend it. \_\_\_\_\_

(6 marks)

### 4 Complete the sentences with the verbs in the box, using the correct form of the present simple.

control cool enter flow heat rise

- 1 The hot water \_\_\_\_\_ the system.
- 2 Hot air \_\_\_\_\_ to the top of the room.
- 3 The thermostat \_\_\_\_\_ the temperature in the room.
- 4 The Sun \_\_\_\_\_ the water in the panel.
- 5 The fan \_\_\_\_\_ the air in the room.
- 6 Hot water \_\_\_\_\_ out of the shower head.

(6 marks)

### 5 Make sentences with the prompts using *if*. Add punctuation in the correct place.

- 1 the Sun / shine / the current / flow / into the lamps  
\_\_\_\_\_
- 2 you / stretch / this nylon rope / it / not break  
\_\_\_\_\_
- 3 the water / be / cold / it / sink / to the bottom  
\_\_\_\_\_
- 4 you / heat / the ceramic / it / not burn  
\_\_\_\_\_
- 5 the ice / melt / the water / rise  
\_\_\_\_\_

(5 marks)

### 6 Complete the sentences and the question, using the correct form of the present continuous.

- 1 They (1) \_\_\_\_\_ (drive) the car down the road.
- 2 Where's Ali? He (2) \_\_\_\_\_ (not sit) in front of his computer.
- 3 Look. I (3) \_\_\_\_\_ (drop) the weight on the plastic block. It (4) \_\_\_\_\_ (not break).
- 4 A: What (5) \_\_\_\_\_ you \_\_\_\_\_ (do)?  
B: I (6) \_\_\_\_\_ (dive) into the swimming pool.

(6 marks)

### 7 Match the questions with the answers.

- |  |                          |
|--|--------------------------|
| 1 Is that Jamal?                         | a) I work in the shop.   |
| 2 When does Frank go to college?         | b) Fine. Thanks.         |
| 3 How are things?                        | c) Graphite.             |
| 4 What's it made of?                     | d) Yes, I am.            |
| 5 Are you swimming?                      | e) Yes, it is.           |
| 6 What do you do on Saturday afternoons? | f) On Thursday evenings. |

(6 marks)

## Part 2: Reading and writing

### Reading

Read the text and answer the questions.

### The Dreamliner

Boeing's 787 Dreamliner was the first eco-friendly jet airliner to fly. It made its first commercial journey in 2011. It travelled at the same speed as other jet planes, but used 20 percent less fuel. The Dreamliner was the first airliner to use mostly composite materials that are very light, strong and corrosion-resistant. Fifty percent of the plane is made of a carbon fibre composite and only 20 percent of the plane is made of aluminium. The skin of the fuselage and the wings are almost completely made of the carbon fibre reinforced plastic. The first Dreamliner planes had a 'raked' wingtip, which is a wing that bends up at the end. This helps lift the plane off the ground when it ascends. In 2020, Boeing started flying planes with wings that are about 72 metres long, this gives more lift and improves take-off time.

- 1 What type of material is most of the Dreamliner made of?  
\_\_\_\_\_
- 2 What are the properties of this material?  
\_\_\_\_\_
- 3 Name two parts of the plane that use this main material.  
\_\_\_\_\_
- 4 What helps the plane ascend?  
\_\_\_\_\_
- 5 What is different about the wings of the first Dreamliner planes?  
\_\_\_\_\_

(5 marks)

### Writing

Write a description of this system, using the notes and the flow chart below.

|                       |   |
|-----------------------|---|
| <b>Name of system</b> | automatic fire sprinkler system   |
| <b>Function</b>       | controls and puts out fires   |
| <b>Main parts</b>     | pipes with sprinkler head and a fusible link (a heat-sensitive element); the pipes contain water under pressure |
| <b>Location</b>       | walls and ceilings of buildings   |

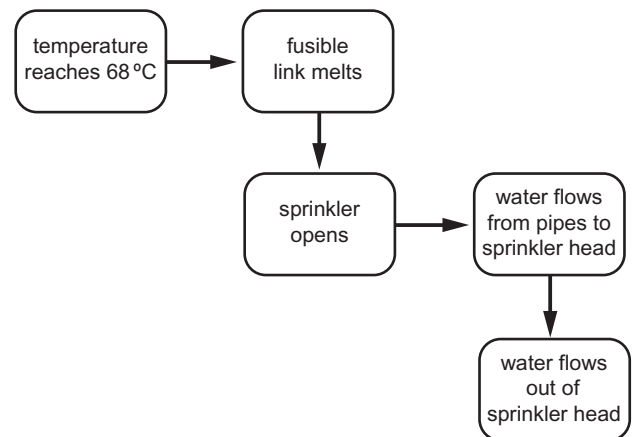

(5 marks)

## Contents

### 1 Dimensions

#### Objectives

In this section, students will ...

- do a quiz about the Millau Bridge
- listen to a TV interview and check answers to the quiz
- identify parts of a bridge in the photo
- listen and complete a specification chart about the dimensions of a bridge
- complete a table with adjectives to do with measurement and their nouns
- complete sentences with the correct nouns or adjectives
- study ways of asking and answering questions about specifications
- make questions based on the specification chart about the Millau Bridge
- ask and answer questions in pairs about the Millau Bridge
- ask questions about a partner's bridge to complete a specification chart

### 2 Quantities

#### Objectives

In this section, students will ...

- do a quiz, matching questions to the buildings and writing an approximate height for each one
- listen and check answers to the quiz
- match FAQs (frequently asked questions) from a website about Burj Khalifa to answers
- study countable and uncountable nouns
- complete a dialogue about buying things in a shop
- make dialogues with a partner about buying things in a shop using information from a table

### 3 Future projects

#### Objectives

In this section, students will ...

- identify a vehicle in a picture and describe how it moves
- listen to a discussion about the Trans-Atlantic tube and complete a specification chart
- study the use of *will*/*ll*/*won't* to predict a future fact or event
- practise using the future with *will* by disagreeing with and correcting statements
- read an interview about the future Europe-Africa bridge and produce a specification chart
- ask and answer questions about the specifications of the bridge
- roleplay an interview between a TV presenter and an engineer based on a project schedule for the bridge
- discuss how things will change in the next 20 years

## Briefing

This unit deals with ways of specifying dimensions and quantities, relevant to a range of manufacturing and construction projects. Specifications are used when ordering or buying equipment.

### 1 Dimensions

Section 1 looks at the specifications of some major **bridges**, the Millau Bridge in France, the Rion-Antirion Bridge in Greece and the Akashi-Kaikyo Bridge in Japan. The French and Greek bridges are examples of **cable-stayed** design, and the Japanese bridge is an example of a traditional **suspension** design. In fact, a cable-stay bridge is a special type of suspension bridge. (Other common types of bridge not mentioned here are the **beam** bridge and the **arch** bridge.) Bridges have a strong horizontal structure, the **deck**, normally made of steel, which carries road or rail traffic. In beam and arch bridges, the deck rests on two or more supporting structures, called **piers** or **columns**. In suspension and cable-stay bridges, the deck is suspended by **cables** from tall structures called **towers** or **pylons**, which rest on the piers or columns. The photograph on page 53 shows the tall steel towers of the Akashi-Kaikyo Bridge resting on concrete piers just above the water level. The photo of the Millau Bridge on page 52 shows tall pylons above the deck resting on tall piers (or columns) below the deck. A **span** is the distance between two piers or columns. The height and width of the **central** (or **inner**) span of a bridge is very important, because ships or other traffic may have to pass through it.

### 2 Quantities

Section 2 focuses on **high-rise buildings**. What are the criteria for deciding which are the world's tallest buildings? The rules used by the Council on Tall Buildings and Urban Habitat (CTBUH) are that (1) a 'building' must be intended for residential, business or manufacturing purposes, and have **floors** or **storeys**, so that a tower or mast would not be included; and (2) the height is measured from the road level of the main entrance to the structural top of the building. This can include a narrow **spire** which is part of the construction, but does not include TV or radio antennas, or flagpoles which are added to the building. Although the One World Trade Center has an antenna on the roof, it is still considered to be 541 metres tall, which includes the antenna. This apparent exception to the rule is probably because the original design included a spire instead of an antenna. High-rise buildings need **lifts** (or **elevators** in American English), to reach the top. The **footprint** of a building (or a piece of equipment) usually means the **area** of its **base**, although it can also refer to its shape.

### 3 Future projects

Section 3 looks at possible projects well into the future. It has to be said that the Trans-Atlantic MagLev Tube and the Europe-Africa Bridge may never actually be built. At the moment they are only ideas or possibilities. Magnetic levitation transport, or **maglev**, is a form of transportation that suspends, guides and propels vehicles (especially trains) using electromagnetic force. The train hovers above, and moves over, the magnetic rail. This method can be faster than wheeled transport systems, potentially reaching speeds comparable to jet aircraft (900 km/h). The highest recorded speed of a maglev train (by 2021) is 600 km/h, achieved in China in 2021. A vacuum in the proposed Trans-Atlantic Tube will eliminate air friction and the train could potentially travel at over 8000 km/h. The Europe-Africa Bridge on page 57 may never be built because of the difficulties of building such a long bridge and the dangers of high winds. An alternative possibility being considered by engineers is to dig a tunnel below the Mediterranean to link Africa with Spain.

#### Further reading online

Enter these search suggestions to find out more about the topics below:

**Rion-Antirion Bridge:** *road traffic technology rion-antirion*

**Millau Bridge:** *millau viaduct*

**Akashi-Kaikyo Bridge:** *road traffic technology akashi kaikyo*

**bridge design:** *howstuffworks bridge*

**tallest skyscrapers in the world:** *skyscraper page diagrams*

**maglev trains:** *transatlantic maglev tube*

**Europe-Africa bridge:** *gibraltar europe africa bridge*

## Teacher's notes

### 1 Dimensions

#### Start here

- 1 Ask students to look at the photo of the bridge and answer the questions. Do not confirm answers at this stage.

#### Listening

### 2 7.1

Tell students that they're going to listen to part of a TV programme about the bridge in the photo. Tell them to listen to the recording and check their answers to 1.

Then ask them if they know anything more about the bridge. (They may mention that it's the world's highest road bridge. It was opened in December 2004 and it was designed by the British architect Norman Foster.)

- 1 The Millau Bridge.
- 2 It's in the south of France.
- 3 It's 336.4 m above the river Tarn.

### 7.1

This is a photograph of the Millau road bridge. That's Millau, spelt M-I-L-L-A-U. It's a beautiful bridge and it's very high. In fact, it's one of the highest bridges in the world. It's in the south of France and it crosses the river Tarn. The bridge is 336.4 metres above the river.

- 3 Put students in pairs. Ask them to look at the photo of the Millau Bridge again and to point to the features that they can see.

All of them

#### Extra activity

Ask students to match the parts of the bridge with their definitions.

- |         |   |
|---------|---|
| 1 cable | a) part of the bridge the cars drive on                 |
| 2 deck  | b) the distance from one end of the bridge to the other |
| 3 pier  | c) a tall tower that holds heavy wires                  |
| 4 pylon | d) a thick, strong metal rope                           |
| 5 span  | e) a tall, strong column which holds a bridge up        |

### 4 7.2

Ask students to look at the specification chart for the Millau Bridge. Play the next part of the TV recording for students to complete the chart. Point out the notes in the margin and check that they are pronouncing *millimetre* correctly. They can compare their answers with a partner and then check the answers with the audio script on page 123.

1 cable-stayed 2 December 2004 3 steel  
4 reinforced concrete 5 8 6 342 7 204 8 7 9 90  
10 246 11 2.46 12 32

### 7.2

[P = TV presenter; E = Engineer]

- P:** Yes, the total height of the Millau road bridge is 336.4 metres above the river Tarn. Now I'm talking to the chief engineer of the bridge. So, can I check with you? Three hundred and thirty-six point four is the total height from the top of the pylons to the river, is that right?
- E:** Yes, that's right. That's the total height. The road deck itself is 246 metres above the river. Then the pylons, or towers, rise another 90 metres above the deck.
- P:** I see. And how wide is the river valley at the bridge?
- E:** Well, the valley is almost 2.5 kilometres wide. In fact, the bridge is 2460 metres long, or 2.46 kilometres.
- P:** And how long are the spans?
- E:** They have different lengths. The bridge has two outer spans and six inner spans. The two outer spans are 204 metres long and the six inner spans are 342 metres long.
- P:** How wide is the road deck?
- E:** It's 32 metres wide. It has four lanes of traffic.
- P:** And what's the bridge made of? It's really beautiful, and it looks very light.
- E:** Yes, it looks light because it is light. It uses the minimum material. But it's also very strong. The cables and the road deck are in fact made of steel. The seven piers, of course, are made of reinforced concrete.

#### Extra activity

For extra support, you could photocopy the following text and hand it out to students for them to check their answers.

The Millau road bridge in southern France is very beautiful. It's also one of the highest bridges in the world. It's a cable-stayed bridge and it has seven piers. The bridge uses the minimum material. It looks very light, but in fact it's very strong. The cables and deck are made of steel, and the piers, or columns, are made of reinforced concrete.

The bridge carries traffic over the valley of the river Tarn. Here the valley is very wide (about 2.5 km) and deep. The total height of the bridge above water level is 336.4 metres. The six central or inner spans are 342 metres long and the two outer spans have a length of 204 metres. The road deck is 246 metres above the water level and the pylons, or towers, rise another 90 metres above the road deck. The deck is 32 metres wide and 2460 metres long. It carries four lanes of traffic.

## Vocabulary

- 5 Pre-teach *depth*. Draw a cross section of a river on the board and a double-headed arrow from the river bed to its surface. Tell students that this is the depth of the river. Students complete the table with the missing adjective and nouns. Tell them to look back at the specification chart in 4 to help them.

Check their answers by asking a student to say the adjective, e.g. *high*, and another student to call out the noun: *height*.

Make sure that they're pronouncing the /θ/ sound at the end of *length*, *depth* and *width*. Point out the silent letters *gh* in *high* and *height*, and that the vowel sound in *high*, *height* and *wide* is /aɪ:/, but in *width* it's /ɪ/.

|           |        |        |       |       |
|-----------|--------|--------|-------|-------|
| Adjective | high   | long   | deep  | wide  |
| Noun      | height | length | depth | width |

- 6 Students complete the sentences with the noun or adjective in brackets. Point out to students that the adjectives go after measurement nouns in the answer. To help them, you could write the following on the board:

the bridge is 2 km long  
= *the bridge has a length of 2 km*  
= *the length of the bridge is 2 km*

They can refer to this as they do the exercise.

1 width 2 long 3 depth 4 high 5 deep 6 length  
7 wide 8 height

## Language

### How high is it? It's 100 metres high.

Go through the language box with the class. Explain to students that when asking about dimensions of things you use *How* + adjective.

When answering the question, remind students to put the adjective after the measurement nouns.

## Speaking

- 7 Students make similar questions to the ones in the language box about the Millau Bridge, using the information in the specification chart in 4. They could also ask other types of questions as well, e.g. *What are the cables made of? How many piers are there?*, etc.
- 8 Put students in pairs. They take turns to be the TV presenter and engineer, asking and answering their questions about the Millau Bridge from 7.

## Task

- 9 Put students in pairs. Student B turns to page 118. Ask Student B to look at the diagram of the Akashi-Kaikyo Bridge and information about it, and ask Student A to look at the photo of the same bridge and the specification chart to go with it, which they need to complete. Student A then asks their partner questions about the bridge to complete their specification chart. Students then change roles. Student A turns to page 114 where there is a diagram and information about the Rion-Antirion Bridge. Student B asks Student A questions in order to complete their specification chart on page 118.

### Student A

| Akashi-Kaikyo Bridge: specifications |            |
|--------------------------------------|------------|
| Type of structure                    | Suspension |
| Country                              | Japan      |
| Piers (number)                       | 2          |
| Span (length)                        | 1991 m     |
| Deck (above water)                   | 65 m       |
| Deck (length)                        | 3911 m     |
| Water (max depth)                    | 110 m      |
| Water at main pier (depth)           | 45 m       |

### Student B

| Rion-Antirion Bridge: specifications |              |
|--------------------------------------|--------------|
| Type of structure                    | Cable-stayed |
| Country                              | Greece       |
| Piers (number)                       | 4            |
| Span (length)                        | 560 m        |
| Deck (above water)                   | 52 m         |
| Deck (length)                        | 2252 m       |
| Deck (width)                         | 26.2 m       |
| Pylon (above deck)                   | 115 m        |

## 2 Quantities

### Warmer

Ask students to name the tallest building they know of, and to tell the class where it is and its approximate height, i.e. how tall they think it is, if they can. You could prompt them to say *It's about ... metres high*.

### Start here

- 1 Students do the quiz. Explain that these are pictures of some of the tallest buildings in the world. Students read the names of the buildings and write the correct picture number and the approximate height for each building. They can then discuss their answers with a partner. Do not confirm answers at this stage.

### 2 7.3

Play the recording for students to check their answers to 1.

- A Picture 6; height 541 m
- B Picture 5; height 556 m
- C Picture 3; height 601 m
- D Picture 7; height 530 m
- E Picture 4; height 599 m
- F Picture 1; height 828 m
- G Picture 2; height 632 m

### 7.3

Picture 1 is Burj Khalifa in the UAE. Its height is 828 metres.

Picture 2 is the Shanghai Tower in China. Its height is 632 metres.

Picture 3 is the Abraj Al Bait in Saudi Arabia. Its height is 601 metres.

Picture 4 is the Ping An Finance Centre in China. Its height is 599 metres.

Picture 5 is the Lotte World Tower in Korea. Its height is 556 metres.

Picture 6 is One World Trade Center in the USA. Its height is 541 metres.

Picture 7 is Guangzhou CTF Finance Centre in China. Its height is 530 metres.

## Reading

- 3 Ask students if they know any more information about the buildings in 1.

Explain to students that the footprint of a building is the area of the base of a building and ask them to read the notes in the margin. Tell students that you can say *floor* or *storey*. Then ask them to read the FAQs (*frequently asked questions*) and match the questions to the answers. They could then compare their answers with a partner before you check with the class.

1 D 2 F 3 C 4 B 5 E 6 A

### Extra activity

You could ask students to find the answers to the frequently asked questions listed for the other buildings in 1 on the internet for homework and check their answers at the beginning of the next lesson.

## Language

### Countable and uncountable nouns

Go through the language box with students. Explain that countable nouns are things which can be counted. You can use *a/an* and numbers with these nouns, e.g. *a nut, one nut*. Countable nouns also have plural forms, e.g. *some nuts/three nuts*. Uncountable nouns are things such as liquids and materials, e.g. *water, cement*, etc. which can't be counted. They don't have plurals and you can use *some*, e.g. *some water*. However, when liquids or materials are in containers, such as in a bag, you can count the containers, so you use countable nouns: *three bags of cement, two bottles of water*, etc.

Explain that in *Wh-* questions, when you ask about quantities, you use *many* for countable nouns and *much* for uncountable nouns, and you use *any* in *Yes/No* questions. (Note that you can also use *some* in questions when the question is a request.)

Tell students that they'll find more information on countable and uncountable nouns in the *Grammar summary* on page 104 of the Course Book.

- 4 Before students start, write *How many ...?* and *How much ...?* on the board. Say: *I need some paint* and prompt them to ask the question *How much paint do you need?* Then say: *I need some nails* and prompt them to say: *How many nails do you need?* Say a few other items that you need and prompt students to ask *How much* or *How many* questions.

Ask students to look at the photo of the hardware shop. Tell them to complete the conversation the two men are having in the shop with the words in the box. Point out that they need to use a word or a phrase for each blank.

You could then get students to practise the dialogue in pairs.

When they finish, go through some useful phrases that you can use when buying things in a shop, e.g. *Do you have any ...?, I need some ... , I'd like ... , Can I help you? Anything else?* Point out that *anything else* is short for *Do you need anything else?* and means *Is there something more you need?*

- |             |               |
|-------------|---------------|
| 1 any       | 4 some        |
| 2 What size | 5 What colour |
| 3 how many  | 6 how much    |

- 5 Ask students to look at the pictures. Explain that these are four types of containers. Ask them to say what types of things you could find in these containers. Then ask students to look at the item column in the table on the right and to find the items that come in the containers. Explain that *What kind?* means the same as *What type?*, so you can ask questions like *What kind of paint?* or *What type of paint?* Then point out the note about litres in the margin.

Now ask students to use the questions in the box and the information in the table and make similar dialogues to the one in 4. Tell them to take it in turns to be the customer and the shopkeeper. Go round the class, listening to their conversations, praising or encouraging them, and making any notes of any problems. When they've finished the activity, go through some of the problems with the class, focusing on errors to do with countable and uncountable nouns.



### 3 Future projects

#### Start here

- 1 Put students in pairs. Ask them to look at the picture and answer the questions.

It's a MagLev train. It runs on a magnetic track.

#### 2 7.4

Ask students to look at the specification chart for the MagLev tube. Tell them that they're going to listen to a radio interview with a civil engineer, who's talking about the MagLev tube, and that he will provide the information for them to complete the chart. Play the recording for students to complete the chart. Then ask them to look at the audio script on page 123 to check their answers.

- 1 Under the Atlantic Ocean from Britain to the USA
- 2 2100
- 3 5000 km
- 4 100 m
- 5 100,000
- 6 8000 km/h
- 7 magnetism

#### 7.4

[T = Tom; Dr J = Dr Jensen]

**T:** Today on RadioTech, I'm talking to Dr Tore Jensen. He's a civil engineer and his company is working on plans for a tunnel under the Atlantic Ocean. So, Tore, tell me about this tunnel, or tube, under the Atlantic. Are you building it now?

**Dr J:** No, no, we're not building it now. That's a long time in the future. Right now, we're thinking about it and planning it. Another company is designing a small-scale model.

**T:** So, when will they build it?

**Dr J:** I think they'll start in 2080 and complete it in 2100.

**T:** Wow! That is a long time in the future.

**Dr J:** Yes, it is!

**T:** So, where will the tunnel be? How long will it be? How deep?

**Dr J:** The tube will be below the Atlantic Ocean. It'll connect the USA with Britain. It'll be about 5000 km long and about 100 metres deep in the ocean.

**T:** Will the tube move around in the water?

**Dr J:** No, it won't move. One hundred thousand cables will attach it to the sea floor.

**T:** Will the train use electricity?

**Dr J:** No, it won't. It'll use magnetism. The tube will contain a vacuum. MagLev trains will be able to travel through the tube at 8000 km/h.

### Language

#### **Will and won't to predict a future fact or event**

Go through the language box with students. Explain that you use *will* to talk about future predictions. You form it with the infinitive without *to*. Students often make the mistake of using this form with *to* to begin with, e.g. *They will to build it in 2050*. Also draw their attention to the question forms and the short answers.

Point out the contracted forms *'ll* in the positive sentences, and tell students that this is pronounced /ʊl/. Then point out the contracted form for *will not – won't*. Tell students that they should always use these contracted forms when they're speaking.

Tell students that they'll find more information on *will* in the *Grammar summary* on page 101 of the Course Book.

- 3 Ask students to look at the statements. Tell them that they all contain a mistake. The correct information is in the brackets. Tell them they should disagree with each statement and correct it as in the example.

- 1 The engineers won't start the tube in 2060. They'll start it in 2080.
- 2 The tube won't be under the Pacific Ocean. It'll be under the Atlantic Ocean.
- 3 The tube won't connect Britain with Europe. It'll connect Britain with the USA.
- 4 The train won't use diesel. It'll use magnetism.
- 5 The tube won't contain compressed air. It'll contain a vacuum.
- 6 The trains won't travel at 11,000 km/h. They'll travel at 8000 km/h.

#### **Extra activity**

This exercise on disagreeing with a statement provides students with the opportunity to do some work on contrastive stress. Write the first answer on the board as an example, underlining the information that was incorrect and the corrected information: *The engineers won't start the tube in 2060. They'll start it in 2080*. Read the sentence out loud to the class, emphasising the words underlined to show contrastive stress. Then put students into pairs. Ask them to take turns with one student reading out the statements, and the other student correcting them, using contrastive stress. Make sure that they're using the contracted forms *'ll* and *won't*.

## Reading

- 4 Ask students to look at the picture of the Europe-Africa Bridge. Tell them that this is another future project. Ask them what countries they think the bridge will join. Then tell them to read the text about the bridge and produce a specification chart like the one on page 56 about the tube, using the words in the box. Do not confirm their answers at this stage.

## Speaking

- 5 Put students in pairs. Students take it in turns to ask and answer questions about the specifications of the bridge using the information from their charts. Then check their answers to 4.

| Europe-Africa Bridge        |                           |
|-----------------------------|---------------------------|
| Location of bridge          | Between Morocco and Spain |
| Possible date of completion | 2045                      |
| Length of deck              | 15 km                     |
| Material of deck            | fibreglass                |
| Number of piers             | 3                         |
| Pylon (height)              | 1000 m                    |
| Total number of spans       | 2                         |
| Span (length)               | 4800 m                    |

- 6 Ask students to look at the chart. Tell them that it shows a possible project schedule for the Europe-Africa Bridge. It gives details when the different parts of the project will start and when they'll finish. Tell students that they're going to roleplay an interview between a TV presenter and an engineer about the future project, using the information from the chart.
- Go through the example exchange under the chart first with students. Explain that you use *in* for a complete year, e.g. *We'll finish in 2042*, and *at* for the beginning or the end of a year, e.g. *We'll open the bridge at the end of 2047*.

## Social English

- 7 Ask students to discuss the question in small groups. Then give feedback, asking students about any interesting changes their group discussed.

### Extra activity

Students could think about a future project they're working on, or they can invent one, possibly for a bridge or a building, like the ones in the previous two lessons, and write a project schedule for it. (They could write months rather than years at the top of the chart if appropriate.) They then tell their partner what the project is and tell them about the schedule for it.

## Contents

### 1 Recent incidents

#### Objectives

In this section, students will ...

- describe what's happening in a photo and list common car problems
- listen to an emergency phone call and complete the details of a crash recovery form
- listen and match phone calls with pictures of incidents
- complete sentences describing the incidents using the present perfect
- study the present perfect to report recent actions
- review regular and irregular forms of the past participle
- make short dialogues with a partner to check progress in a car workshop using the present perfect
- do a memory test by identifying the differences in two building sites, four minutes apart
- make sentences to explain what has happened in the later picture using the present perfect

### 2 Damage and loss

#### Objectives

In this section, students will ...

- describe damage that has happened to their own equipment or tools
- revise verbs to do with damage and match verbs to pictures
- correct the mistakes in a checklist of damage done to a VR headset by checking the damage in the picture of it
- listen and compare what's said in a telephone conversation about the damage to the radio against the checklist
- make sentences about the damage and things that are missing using sentence patterns
- study ways of focusing on an action and focusing on the result of an action
- rewrite sentences to give the same meaning
- complete sentences with adjectives to do with damage
- ask and answer questions to find out about damage to their partner's car and label a diagram

### 3 Past events

#### Objectives

In this section, students will ...

- do a quiz and say when events in the history of space travel happened
- check answers against a chart with names of events and dates
- study the past simple
- make questions and answers based on the chart of events
- study using *ago* with times, days, weeks, months
- practise saying the days and weeks from a calendar with *ago*
- make sentences with *ago* from the chart of events about space travel
- listen to a phone conversation with customer services about damage and complete it with present perfect or past simple verbs
- make similar phone conversations with a partner using information from a table
- make a list of interesting things they have done in their life with dates
- ask and answer questions about their list with the whole class

## Briefing

This unit deals with ways of reporting recent incidents, damage and loss (for example in a delivery of goods or equipment), and past events.

### 1 Recent incidents

Section 1 begins with an incident in which a motorist reports a recent **breakdown** by phone to a crash recovery company (in 2). The motorist has **broken down** on a stretch of fast dual-carriageway road with limited access and exit at numbered **junctions**. This is why, to identify the car's **location** (position), the company needs to know the road number (A13), the junctions on either side of the car (*between Junction 15 and 16*) and the direction of travel (*going south*).

The present perfect form of the verb is introduced here for reporting a recent incident. In the exercises on page 58, someone is urgently reporting an incident that has happened in the recent past (*I've driven my car into a bridge*). In these cases, the present perfect is appropriate because the important information is the incident itself, not the time when it happened. In later questioning, the authorities may ask about times (e.g. *When exactly did the accident happen?*) in which case the past simple is used. But the initial reporting of the incident requires the present perfect. In 6 on page 59, the supervisor only wants to know if the job has been done (*Have you checked the brakes?*) not the time when it was done. In 7 on page 59, the student's task is to report what has changed in the four minutes between 10.12 am (on page 117) and the present moment (10.16 am): *Two builders have taken off their jackets*.

### 2 Damage and loss

Section 2 takes this grammar point a little further by exploring the relationship between the present perfect and the use of the past participle as a predicative adjective. *Someone has dented the controller* uses the present perfect to report an action in the recent past. *The controller is dented* conveys similar information but emphasises the present state which is the result of the action. In technical contexts, the past participle is frequently used as an adjective to denote some damage: *the bar is bent, the box is dented, the lens is scratched, the glass is broken* and so on. To **dent** something is to make a slight hollow in a surface: if someone stood on the roof of a car, they would probably dent it. **Cracked** and **broken** are different mainly in degree: a *cracked* windscreen would be called *broken* if pieces have started falling out. The verbs of damage listed in 2 (*bend, break, dent, etc.*) can also be used as nouns: this is why in 5 we can say: *the lens is scratched* and *there is a scratch (n) on the lens*. Section 15 in the *Grammar summary* (page 105) gives more information on the variety of forms that can be used to describe damage or loss.

### 3 Past events

Section 3 introduces the past simple as a way of reporting events where the time and date are important issues. In the reading text on the history of space flight, *Galileo* is mentioned: this is the European version of GPS, the global satellite positioning system. In 6 on page 63, we find the customer using the present perfect to make the initial report of damage (*I've broken my tablet, I've broken the screen*) and then the electronic repair person using the past simple to ask about specific times (*When did you buy it? When did you break the screen?*).

#### Further reading online

Enter these search suggestions to find out more about the topics below:

**history of space exploration:** *aerospace history space exploration*

**European space agency:** *esa space*

**NASA space agency:** *nasa space*

## Teacher's notes

### 1 Recent incidents

#### Start here

1 Put students in pairs. Ask them to look at the photo and to make a list of the five most common problems you can have with a car. Tell them to use a dictionary to help them if necessary.

#### 2 8.1

Tell students that the woman in the photo is phoning a recovery company. They're going to listen to her giving her details on the recording and they must complete the information on the form. Explain that they'll need to write the number of the road and what the junction is. You could draw a diagram on the board of a motorway with two junctions and add a simple drawing of Ms Zubaid's car between them to illustrate the word. Play the recording for students to complete the form.

|                |         |                  |
|----------------|---------|------------------|
| 1 Anita Zubaid | 4 15    | 7 has fallen off |
| 2 BG71 TPA     | 5 16    |                  |
| 3 M13          | 6 south |                  |

#### 8.1

[PO = Phone operator; D = Driver]

**PO:** Hello. Crash Recovery Company. How can I help you?

**D:** Oh hi! I've broken down on the motorway!

**PO:** OK, don't worry. What's your name and car registration number?

**D:** My name's Anita Zubaid. That's Anita spelt A-N-I-T-A Zubaid, spelt Z-U-B-A-I-D. The car is BG71 TPA.

**PO:** And where are you, Ms Zubaid?

**D:** I'm on the M13. Between Junctions 15 and 16. Going south.

**PO:** Right. And what's the problem?

**D:** Well, the exhaust pipe has fallen off.

**PO:** OK. We'll be there in 30 minutes. Stay with your car, please.

**D:** All right. Bye.

#### Listening

#### 3 8.2

Ask students to look at the pictures in the margin and ask them what they can see. Then play the recording for students to match the phone calls with the pictures.

1 B 2 D 3 C 4 A

#### 8.2

1 [C1 = Caller 1; S = Security]

**C1:** Hello? Hello? Is that Security?

**S:** Yes, Security here. How can we help?

**C1:** Some thieves have broken into my office. They've taken my computer.

2 [IT = IT technician; C2 = Caller 2]

**IT:** IT department. How can I help you?

**C2:** Is that the IT hotline?

**IT:** Yes. What's the problem?

**C2:** Something has happened to my computer. I've lost all my data.

3 [EO = Emergency phone operator; C3 = Caller 3]

**EO:** Emergency. Which service?

**C3:** I need an ambulance, quickly.

**EO:** What's happened?

**C3:** It's my daughter. She's fallen down some stairs. She's cut her leg.

4 [PO = Phone operator; C4 = Caller 4]

**PO:** Crash Recovery. How can I help you?

**C4:** Oh, hello. Yes. I've had an accident. I've driven my car into a bridge.

4 Ask students to look back at picture A and ask: *What's happened?* Accept any answers, then go through the language notes with the class.

Ask students to complete the sentences with the verbs in the box. Point out that they need to use the auxiliary *have* or *has* plus one of the verbs from the box in each of the gaps.

|                          |                       |
|--------------------------|-----------------------|
| 1 have broken; 've taken | 3 has fallen; 's cut  |
| 2 has happened; 've lost | 4 've had; 've driven |

#### Language

##### Present perfect with *have/has* + past participle

Explain that you can use the present perfect to talk about recent actions – when the action happened isn't important, as we're interested in now. Point out that you never use the present perfect with dates, times or certain time expressions. You have to use the past simple with these.

Tell students that you form the present perfect with the auxiliary verb *have* (*has* with *he/she/it*) and the past participle. Point out that the contracted form of *have* is *'ve* and *has* is *'s* and that they should use these contracted forms when speaking.

Explain that to make the past participle form of regular verbs you simply add *-ed*, *-d* or *-ied* to the verb, e.g. *check – checked*, *close – closed*, *study – studied*. Tell students that there is a list of regular and irregular verbs in the *Grammar summary* on page 103 of the Course Book, and that they'll find more information on the present perfect in the *Grammar summary* on page 102 of the Course Book.

5 Ask students to look at the infinitive verbs and to write the past participle of the verbs. They can then check with a partner and discuss which ones are irregular. Students can check the irregular verb list in the *Grammar summary* on page 103 of the Course Book.

|                   |                 |
|-------------------|-----------------|
| buy – bought      | sell – sold     |
| check – checked   | send – sent     |
| crash – crashed   | speak – spoken  |
| fall – fallen     | steal – stolen  |
| order – ordered   | take – taken    |
| put – put         | write – written |
| repair – repaired |                 |

*buy, fall, put, sell, send, speak, steal, take* and *write* are irregular verbs.

*check, crash, order* and *repair* are regular verbs.

## Speaking

- 6** Put students into pairs. Ask them to look at the photo of the supervisor and the mechanic in the car repair workshop. Then to look at the list of jobs they have or haven't done. Tell students to look at the first sentence and ask a couple of students to read out the dialogue below to make sure that they know what to do. Point out the auxiliary *have* at the beginning of *Yes/No* questions in the present perfect, and that you use the same auxiliary verb in the short answers.
- 7** Ask students if they have a good memory. Then tell them that they're going to do a memory test. Ask them to turn to page 117 and look at the picture for one minute. They should try to remember as much detail about the picture as they can. Help them by telling them to look carefully at what the three builders are doing and where they, the crane and the digger are. Point out the time: *10.12 am*. Then ask students to turn back to page 59 and look at the picture in 7. Point out that this picture shows the scene four minutes later, at 10.16 am. Give them a couple of minutes to try to remember the differences in the picture on page 117. They can then compare the differences they found with their partner. Do not confirm answers at this stage.
- 8** Ask students to look at the picture of the building site in 7 on page 59 again. They can work with a different partner. Ask them to use the words and the verbs in the box to describe what has happened in the building site since 10.12, as in the example, without looking at the picture of that scene at the back of the book.

Students can then write up their answers and compare them with their original partner's answers.

- 1** Two builders have taken off their jackets.
- 2** The builder on the left has climbed down from the scaffolding.
- 3** The crane has lowered the beam.
- 4** The digger has raised its bucket.
- 5** The digger has moved back./A builder has driven the digger back.
- 6** The bricks have fallen over.
- 7** The builder in the middle has put on his hard hat.
- 8** The builder on the right has put down the saw.
- 9** The builder on the right has picked up a sledgehammer.
- 10** The builders have put their jackets on the drum.

### Extra activity

Play a memory game with students. The object of the game is for students to find out what changes you've made to the classroom and to what you're wearing.

Tell students to look carefully around the class and at you for ten seconds. Then tell them to close their eyes while you quickly make changes to where things are in the classroom and to your appearance, e.g. if you wear glasses, put these on the desk, if you have a jacket with you, put it on, etc.

Students then open their eyes and tell you what changes have been made, using the present perfect tense. They could then play this game in pairs.

## 2 Damage and loss

### Start here

- 1 Brainstorm a list of tools and equipment and write the words up on the board. Then put students in pairs. Ask them to think of any tools or equipment they have that is damaged and describe the damage to their partner.

### Vocabulary

- 2 This exercise revises verbs students have studied in Unit 6. Ask them to look at the pictures. They match the pictures with the verbs in the box.

1 bend 2 cut 3 scratch 4 tear 5 dent 6 crack  
7 break 8 burn

### Task

- 3 Ask students to look at the picture in the Quick Start guide. Tell them to imagine that they've just bought this VR headset kit. Ask them what's wrong with it and accept any answers. Tell them that there's a checklist for the headset in the box. However, the checklist contains mistakes about what is in the box and the condition of some of the items. Ask students to look at the illustration and correct the mistakes in the checklist. When they've finished, they can compare their list with a partner. Do not confirm answers at this stage.

### Listening

#### 4 8.3

Ask students to look at the picture in 3 again. Tell students that they're going to listen to a telephone conversation with a customer phoning Customer Services about the VR headset kit. Play the recording for students to check their list and correct any items they missed. Then ask students to look at the audio script on page 124 and check their answers.

| item                     | in box       | condition       |
|--------------------------|--------------|-----------------|
| VR headset               | ✓            | damaged         |
| • strap for head         |              | ✗ cut           |
| • body of headset        |              | cracked         |
| • lenses for eyes        |              | ✗ one scratched |
| charging cable with plug | no plug      | cable OK        |
| lithium ion battery      | ✗ no battery | ✗               |
| user manual              | no manual    | –               |
| pair of controllers      | ✓            | damaged         |
| • LH controller          | ✓            | ✗ bent          |
| • RH controller          | ✓            | dented          |
| nylon carrying bag       | ✗ no bag     | ✗               |

#### 8.3

[D = Del; E = Mr Ericsson]

- D:** Customer Services. Del speaking. Please give me your order number.  
**E:** AX 5831-77 ...  
**D:** Ah yes, Mr Ericsson. You've bought a VR headset kit from us. How can I help you?  
**E:** I've opened the box and taken out the headset. There's some damage and there are some missing items.  
**D:** I'm sorry to hear that. What's missing?  
**E:** The USB charging cable has no plug.  
**D:** No ... plug ... with ... cable. OK. Anything else?  
**E:** Yes. There's no battery and no carrying bag.  
**D:** No battery ... and no bag. OK. Is that all?  
**E:** No. There's no user manual.  
**D:** User manual ... missing. Anything else?  
**E:** There's some damage. The body of the headset is cracked. There's a scratch on one lens ... and the head strap is cut.  
**D:** Lens ... scratched. Body ... cracked. Head strap cut. OK. Is there any more damage?  
**E:** Yes. One of the controllers is bent and the other controller is dented. And there's a hole in it.  
**D:** Oh dear, I do apologise for all that. Please put everything in the box again. We'll collect it from your house tomorrow. Then we'll send you a new VR headset kit.  
**E:** OK.  
**D:** Goodbye, Mr Ericsson. Thanks for calling.

### Speaking

- 5 Ask students to look at the table of the ways to report damage and the ways to report when something is missing. Then write these phrases on the board:

*There is a ...*

*The ... is scratched.*

*There's no ...*

*The ... is missing.*

Ask students to look at the picture in the Quick Start guide and cover the table in 5. Ask them to tell you something that's wrong with the VR headset kit, using one of the phrases on the board.

Then ask students to write similar sentences about the damage to the VR headset kit and the items that are missing. Ask them to try to use all the different ways to report the damage or missing item.

The headset is damaged.

The controller is bent.

The body of the headset is cracked.

There's a hole in the controller.

The battery is missing./There's no battery in the box.

There's no plug for the cable./There isn't a plug for the cable.

There's no user manual./The user manual is missing.

## Language

### Focus on action and focus on result of action

Go through the language box with the class. Remind students that they studied the present perfect for recent actions in the last lesson. Draw their attention to the examples in the first column. Tell them that here you're focusing on the action. The example sentences in the second column focus on the result of the action (you're not interested in who has done the action). You form these sentences with a past participle, which is used as an adjective after the verb *be*. *The radio is dented.*

#### Extra activity

To give students extra practice, draw the table below on the board and ask students to complete it.

| Verb    | Past participle  |
|---------|------------------|
| scratch | <i>scratched</i> |
| crack   |                  |
| bend    | <i>bent</i>      |
| burn    |                  |
| cut     |                  |
| tear    | <i>torn</i>      |
| break   |                  |

- 6 Ask students to rewrite the sentences to focus on the result of the action following the same pattern as in the language box. Ask them to read out their answers. Explain that you can pronounce the *ed* endings on regular verbs with a /t/, /d/ or an /ɪd/ sound. When a verb ends in *t* or *d*, such as *need* or *want*, you pronounce *ed* as /ɪd/. With unvoiced sounds /f/, /k/, /p/, /s/, etc., the *ed* ending is pronounced /t/, e.g. *picked*. With voiced sounds /g/, /n/, /v/, etc. the *ed* ending is pronounced /d/, e.g. *phoned*. Watch out for errors where students pronounce verbs that have /t/ and /d/ endings with two syllables, e.g. /hæpənɪd/ for *happened*.

- 1 The display screen is scratched.
- 2 The antenna is bent.
- 3 The body of the headset is burnt.
- 4 The top of the speaker is dented.
- 5 The cover of the plug is cracked.
- 6 The user manual is torn.

#### Extra activity

Write the following headings on the board:

/d/     /t/     /ɪd/

Then tell students to write the following regular verbs under the correct heading: *cracked, climbed, crashed, scratched, dented, moved, raised, repaired*.

- 7 Ask students to look at the pictures and to identify the problem for each one, using the words from the box. They then complete the sentences using the correct form of the words in the box.

1 dented   2 scratched   3 cracked   4 cut   5 bent  
6 torn

- 8 Remind students of the ways to report damage that they studied in 5. Write: *The screen is scratched. There's a scratch on the screen.* to remind them. Then write: *There are some cracks on the headsets*, and explain that you can add *some* before plural nouns when you don't mention the number of items.

Students then rewrite the sentences in 7 to give the same meaning, beginning with *There's a ...* or *There are some ...*

- 1 There's a dent in the side of the box.
- 2 There are some scratches on the lenses of the goggles.
- 3 There are some cracks in the surface of the road.
- 4 There's a cut on the insulation of the cable.
- 5 There's a bend on the pipe below the tank.
- 6 There's a tear in the overalls.

#### Task

- 9 Put students in pairs. Tell them to look at the diagram of the car on the page. Ask them to point out and name other parts of the car and write these on the board. Then ask Student B to turn to page 116 and look at the diagram of the damaged car. Student A asks Student B about the damage to their car and labels the diagram on page 61. They then change roles. Finally, they check the labels on each other's diagram.

#### Extra activity

Tell students that they are the bodywork technician working on the car in 9. Tell them to look at the diagram of the damaged car and ask them to write an email to the customer, describing the damage to the car, using the language they've studied in this lesson.



### 3 Past events

#### Start here

- 1 Ask students to look at the photos on the page and to identify what they can see (*a space shuttle, a satellite, an astronaut fixing a space station*). Pre-teach *telescope* (*you look through this to make objects far away look bigger*), and *crew* (*people who work on a ship, plane, space station, etc.*) and ask them what a space tourist does.

Then put students in pairs. Tell them to cover the text in 2 and tell them that they're going to do a space quiz. Ask them to look at the list of events and tell them to work with their partner and give the approximate year for these events. Give them a time limit of five minutes to complete this activity. Do not confirm answers at this stage.

#### Reading

- 2 Ask students to read the chart and check their answers to 1. Explain that *launch* means to send a space shuttle/satellite, etc. into space.

- 1 helicopter flight on Mars: 2021
- 2 telescope in space: 1990
- 3 man in space: 1961
- 4 space flight past Pluto: 2015
- 5 satellite: 1957
- 6 spacewalk: 1965
- 7 man on the Moon: 1969
- 8 shuttle in space: 1981
- 9 crew on the International Space Station: 2000
- 10 European navigation satellite: 2005

#### Language

##### Past simple

Go through the language box with the class. Explain to students that you use the past simple tense to talk about completed events in the past. You use it with dates, times or time expressions.

Explain that you form the past simple of regular verbs by adding *-ed*, *-d* or *-ied* to the verb. Some irregular past simple verbs are the same as those in the past participle, but others are different. There is a list of regular and irregular verbs on page 103 of the Course Book.

You form *Wh-* questions in the past simple in the same way as the present simple, but with the auxiliary *did* instead of *do/does*.

Tell students that they'll find more information about the past simple in the *Grammar summary* on page 102 of the Course Book.

##### Extra activity

Ask students to find and underline all the irregular verbs in the past simple in the text. They then write the infinitive of the verb.

#### Speaking

- 3 Students now practise asking and answering questions in the past simple. First, ask them to look at the note in the margin, which explains the difference between *in* and *on* for dates.

Then tell students to look back at 2. They make questions from the information in the events column, and answer them either using the exact date with *on*, or giving the year using *in*.

## Vocabulary

Explain that you use *ago* with the past simple. It means before now. Go through the examples in the box with students and ask them to read the note in the margin. Tell students that in British English you can use both these ways to say the date, but in American English you say *November the fifteenth*, not *the fifteenth of November*.

- 4 Ask students what month it is and tell them to write it on the line at the top of the calendar. Then ask them to put a circle round today's date. They then say what the dates listed are.
- 5 Students now make statements about the dates in the chart in 2 using *ago* and approximate years from today's date. Point out that for making approximate dates they can use *more than* or *less than* and tell them that they can also use *about* if appropriate. (Note that students have to insert the correct number of years in the spaces below.)

### Possible answers

- 1 The Russians launched Sputnik more than/about ... years ago.
- 2 Yuri Gagarin became the first man in space more than ... years ago.
- 3 Leonov made the first walk in space more than ... years ago.
- 4 The first men, Armstrong and Aldrin, landed on the Moon about ... years ago.
- 5 The Americans put the first shuttle into space more than ... years ago.
- 6 NASA sent the Hubble telescope into space more than ... years ago.
- 7 The first crew entered the International Space Station less than ... years ago.
- 8 The Europeans launched Galileo, a global navigation satellite less than ... years ago.
- 9 The New Horizons spacecraft passed close by Pluto more than/about ... years ago.
- 10 The Ingenuity helicopter performed the first powered, controlled flight on Mars less than ... years ago.

## 6 8.4

Tell students that they're going to listen to a telephone conversation between a customer and a man working at an electronic repair shop. Play the recording once through and ask students to tell you what the problem is. Then play the recording again for students to complete the phone call.

1 broken 2 buy 3 bought 4 dropped 5 cracked  
6 break

## 8.4

[CS = Customer Services; BJ = Ben Jones]

- CS:** Hello, Electronic Repairs. Don speaking. How can I help you?
- BJ:** Hi. My name's Ben Jones. I've broken my tablet. Can you repair it?
- CS:** OK, Ben. What's the model number?
- BJ:** It's a Super 512 GB.
- CS:** And when did you buy it?
- BJ:** Er, let's see ... Yes, I bought it on the 18th of August.
- CS:** And what's the problem?
- BJ:** I've dropped it and I've cracked the screen.
- CS:** And, er ... when did you break the screen?
- BJ:** Yesterday.
- CS:** OK, bring it into the shop and I'll look at it.
- BJ:** Thanks. Bye.

### Extra activity

Ask students to look back at the conversation and circle the verbs in the past simple and underline the verbs in the present perfect. Ask them to explain why they think the speakers used the past simple and why they used the present perfect in this conversation.

- 7 Put students in pairs. Ask students to look at the chart and use the information to make similar phone calls to the one in 6. Go round checking that they're using the past simple and present perfect forms correctly.

## Social English

- 8 Ask students to write a list of interesting things they've done in their life, with the dates.  
Alternatively, if students think they haven't done many interesting things in their life, you could ask them to write a list of some things they've done in their life and some that are invented. In 9, the class can then say which things they think are true and which things they think have been invented.
- 9 You could start this off by writing up a few interesting things in your life and telling the class about them. Students then tell the class about their lists. Alternatively, they could work in small groups and tell each other about their lists.

# Review Unit D

## Answer key

- 1**
- 1 How wide is the road?
  - 2 How high are the pylons?
  - 3 How long is the deck of the bridge?
  - 4 How high is the scaffolding?
  - 5 How deep are the foundations of the building?
  - 6 How long are the steel beams?
- 2**
- 1 deep 2 high 3 wide 4 long
- 3**
- 1 How high is the bridge?
  - 2 The tower is 46 m high.
  - 3 How deep is the sea under the bridge?
  - 4 This new road is 355 km long.
  - 5 How wide are the screws?
  - 6 The well is more than 30 m deep.
- 4**
- 1 How many storeys does the building have?
  - 2 How much cement does the builder need?
  - 3 How many cranes are the men using?
  - 4 How much oil does the car need?
  - 5 How many screws are you buying?
  - 6 How much concrete can ten trucks carry?
- 5**
- Cables (number): 20  
Deck (length): 1.2 km  
Deck (above water): 185 m  
Pier (width) 35 m  
Span (length between piers): 832 m  
Pylon (above deck): 45 m
- 7**
- B: How long will the tunnel be?  
A: It will be 40 km long.  
B: How many railway lines will it have?  
A: It will have two.  
B: How wide will it be?  
A: It will be 8 m wide.  
B: How deep below sea level will it be?  
A: It will be 300 m deep.  
B: When will the engineers complete it?  
A: They'll complete it in 2035.
- 8**
- 1 No, they didn't. They completed it in 2004.
  - 2 No, I haven't. I've worked in a mobile phone repair shop.
  - 3 No, they won't. They'll build a tunnel.
  - 4 No, they aren't. They're planning and designing it now.
  - 5 No, it hasn't. It's put men on the Moon.
  - 6 No, it didn't. It launched it in 1957.
- 9**
- 1 My car has broken down.
  - 2 NASA has launched the space shuttle.
  - 3 A virus has attacked our office computers.
  - 4 I've written the email and I've sent it to the customer.
  - 5 The technician has taken the hard drive out of the computer.
  - 6 The exhaust pipe has fallen off my car.
- 10**
- 1 The wheel has no wheel nuts. / The wheel doesn't have any wheel nuts. / There are no wheel nuts on the wheel.
  - 2 The radio has no batteries. / The radio doesn't have any batteries. / There are no batteries in the radio.
  - 3 The light has no bulb. / The light doesn't have a bulb. / There's no bulb in the light.
  - 4 The cable has no plug. / The cable doesn't have a plug. / There's no plug on the cable.
  - 5 The socket has no cover. / The socket doesn't have a cover. / There's no cover on the socket.
  - 6 The car has no tyres. / The car doesn't have any tyres. / There are no tyres on the car.
- 11**
- 1 The front bumper is dented.
  - 2 The windscreen is broken.
  - 3 The rear seat of the car is burnt.
  - 4 The poles of the scaffolding are bent.
  - 5 The safety jackets are torn.
  - 6 The rear panel of the car is scratched.
- 12**
- 1 The antenna is bent. / There's a small bend in the antenna.
  - 2 The walls are burnt. / There are two large burns on the walls.
  - 3 The window is cracked. / There are some cracks in the window.
  - 4 My shirt is torn. / There's a tear in my shirt.

- 13**
- 1 This cover is scratched.
  - 2 The car has no wheels.
  - 3 There are no plugs on the cables.
  - 4 There are some cracks in the windscreens.
  - 5 This garage doesn't have a workshop manual.
  - 6 The roof of the car is dented. / The roof of the car has a dent.

- 14**
- 1 bought 2 find 3 found 4 keyed 5 did you pay  
6 use 7 gave 8 used 9 did you receive 10 came

- 15**
- The water tower stores water. The main parts of the water tower are water pipes, a pump, a tower and a tank. The tower is made of galvanised steel, and the tank is made of aluminium and fibreglass. The tower is 60 m high and the tank is 10 m wide. The tank can hold five million litres of water.
- Water flows to the pump. The pump pushes the water to the city. Extra water flows up into the tank. The tank stores the water. The extra water flows down from the tank to the city.

### Projects

- 16** At the end of every Review Unit is a project. Students can do their research on the internet or in a library, and in their own language if they wish. They must then write their results in English.

## Quick test answer key

### Part 1: Vocabulary and grammar

- 1**
- |                |               |
|----------------|---------------|
| 1 high, height | 3 deep, depth |
| 2 long, length | 4 wide, width |
- 2**
- 1 bridge 2 material 3 concrete
- 3**
- |                          |                 |
|--------------------------|-----------------|
| 1 12.25                  | 4 two weeks ago |
| 2 an hour ago            | 5 4th May 2022  |
| 3 Saturday 2nd July 2022 |                 |
- 4**
- 1 much 2 any 3 a 4 any 5 many 6 some
- 5**
- 1 Where was it built?
  - 2 When will they complete the building?
  - 3 How long is it?
  - 4 What happened?
  - 5 What do you need?
  - 6 How long is it?

- 6**
- 1 travel – travelled – travelled
  - 2 build – built – built
  - 3 send – sent – sent
  - 4 take – took – taken
  - 5 steal – stole – stolen

- 7**
- |                |                    |
|----------------|--------------------|
| 1 went         | 5 haven't repaired |
| 2 has happened | 6 sold             |
| 3 Will, speak  | 7 'll complete     |
| 4 won't start  |                    |

- 8**
- 1 My computer is broken.
  - 2 The front panel of my car is dented.
  - 3 There is a scratch on the table.
  - 4 There are cracks in the window in three places.

## Part 2: Reading and writing

### Reading

#### The Great Belt East Bridge: specifications

|                                  |            |
|----------------------------------|------------|
| Structure                        | suspension |
| Material: cables                 | steel      |
| Material: piers                  | concrete   |
| Length of main span              | 1624 m     |
| Total number of piers            | 19         |
| Total number of pylons           | 2          |
| Height of pylons above sea level | 254 m      |
| Height of deck above water       | 65 m       |
| Length of deck                   | 6.8 km     |
| Width of deck                    | 25.1 m     |

### Writing

Dear ...

I'm writing about the TV I ordered on 5th July. Order number X-35324. I've opened the box and there's some damage. There's a dent on the back of the TV and the screen is cracked. There's also no manual in the box. So, I can't set up the TV.

Please could you arrange to send me a new TV and to collect the damaged TV. I look forward to hearing from you.

Best wishes

# Review Unit D | Quick test

## Part 1: Vocabulary and grammar

Total \_\_\_\_\_/50

### 1 Complete the questions and answers, using nouns or adjectives.

deep depth height high length long  
wide width

- How \_\_\_\_\_ is the Statue of Liberty?  
The Statue of Liberty is 46.50 m in \_\_\_\_\_ from the base to the torch.
- How \_\_\_\_\_ is the Yangtze River?  
The Yangtze River is over 6300 km in \_\_\_\_\_. It flows from Qinghai Province to Shanghai.
- The Channel Tunnel between England and France is very \_\_\_\_\_.  
It's average \_\_\_\_\_ is 45.7 m below the sea bed.
- The Sydney Harbour bridge is very \_\_\_\_\_. It's about 4.9 m in \_\_\_\_\_.

(4 marks)

### 2 Underline the odd word out in each group.

- 1 pier cable deck pylon bridge
- 2 concrete aluminium nylon material titanium
- 3 bridge building concrete tower tunnel

(3 marks)

### 3 It's 12.30, Monday 4th July 2022. Write the following times, dates and expressions with *ago*.

- 1 \_\_\_\_\_ five minutes ago.
- 2 11.30 \_\_\_\_\_
- 3 \_\_\_\_\_ two days ago
- 4 Monday 20th June \_\_\_\_\_
- 5 \_\_\_\_\_ two months ago

(5 marks)

### 4 Choose the correct words to complete the sentences.

- 1 How *much/many* concrete do you need?
- 2 I don't have *some/any* oil in the car.
- 3 Peter has *a/some* tin of paint.
- 4 Do you need *some/any* water?
- 5 How *much/many* storeys does the Burj Khalifa building have?
- 6 They're building *some/any* new roads this year.

(6 marks)

### 5 Write the questions for these answers. Use *How, What, When, Where*.

- 1 \_\_\_\_\_?  
It was built in the South of France.
- 2 \_\_\_\_\_?  
They'll complete the building in 2010.
- 3 \_\_\_\_\_?  
The total length is 347 km.
- 4 \_\_\_\_\_?  
I fell over the bricks on the floor.
- 5 \_\_\_\_\_?  
I need some blue paint.
- 6 \_\_\_\_\_?  
20 mm in length.

(6 marks)

### 6 Write the past tense and the past participle of these verbs.

|   | Verb   | Past tense | Past participle |
|---|--------|------------|-----------------|
| 1 | travel |            |                 |
| 2 | build  |            |                 |
| 3 | send   |            |                 |
| 4 | take   |            |                 |
| 5 | steal  |            |                 |

(5 marks)

### 7 Put the verbs in the correct tense: the past simple, present perfect or future *will*.

- 1 They \_\_\_\_\_ (go) to Cairo three years ago.
- 2 Is that the IT helpline? Something \_\_\_\_\_ (happen) to my computer. Can you help me?
- 3 \_\_\_\_\_ you \_\_\_\_\_ (speak) to the investigator about the accident tomorrow?
- 4 They \_\_\_\_\_ (not start) the bridge until 2035.
- 5 Sorry, I \_\_\_\_\_ (not repair) your car. I'll do it tomorrow.
- 6 They \_\_\_\_\_ (sell) their first headset in 2019.
- 7 They \_\_\_\_\_ (complete) the building in 2031.

(7 marks)

**8 Rewrite these sentences so that the meaning is the same.**

- 1 I've broken my computer.  
My computer \_\_\_\_\_.
- 2 There's a dent in the front panel of my car.  
The front panel of my car \_\_\_\_\_.
- 3 I've scratched the table.  
There \_\_\_\_\_.
- 4 He's cracked the window in three places.  
There \_\_\_\_\_.

(4 marks)

**Part 2: Reading and writing**

**Reading**

Read the text. Then complete the specification table.

**The Great Belt East Bridge**

The Great Belt East Bridge (*Østbroen*) links the islands of Halsskov and Sprogø in Denmark. It has one of the longest free-standing spans in the world. This span is 1624 m long. The road deck is 25.1 m wide and 65 m above the water, and the total length of the bridge, with the roads leading up to it, is 6.8 km. On the main span, there are two pylons. The pylons are 27 metres below sea level and 254 metres above sea level. The cables attached to the pylons are made of steel. There are 12 concrete piers to support the outer span of the deck on the Halsskov side and seven on the Sprogø side.

**The Great Belt East Bridge: specifications**

|                                  |  |
|----------------------------------|--|
| Structure                        |  |
| Material: cables                 |  |
| Material: piers                  |  |
| Length of main span              |  |
| Total number of piers            |  |
| Total number of pylons           |  |
| Height of pylons above sea level |  |
| Height of deck above water       |  |
| Length of deck                   |  |
| Width of deck                    |  |

(5 marks)

**Writing**

Put the lines a–e in the correct order in this email. Then write the complete email below.

- a) ordered on 5th July. Order number X-35324. I've
- b) cracked. There's also no manual in the box. So, I can't set up the TV.
- c) I'm writing about the TV I
- d) a dent on the back of the TV and the screen is
- e) opened the box and there's some damage. There's

Dear ...

---



---



---



---

Please could you arrange to send me a new TV and to collect the damaged TV.

I look forward to hearing from you.

Best wishes

(5 marks)

## Contents

### 1 Operation

#### Objectives

In this section, students will ...

- discuss in pairs how an airboard moves
- complete a chart with the parts of an airboard that go with the functions
- listen and check answers
- listen and complete a dialogue with present simple forms
- study ways of describing functions of things using the present simple
- make dialogues about the airboard using present simple questions and short answers
- answer questions from a text about how an airboard works
- rewrite sentences to give the same meaning in the present simple
- match pictures with sentences
- complete sentences with phrases which describe how objects are attached

### 2 Hotline

#### Objectives

In this section, students will ...

- listen and choose the correct keys to press from an automated phone message
- listen to a service technician answer the phone and complete the text with what he says
- listen to a phone call to a service hotline and identify a customer's mistake in setting up a hub
- read a dialogue and practise similar phone conversations with a partner
- make more dialogues using two different hub setups
- practise short form answers by giving appropriate short answers to the questions
- listen to questions and repeat the answers
- find the differences between two wiring diagrams

### 3 User guide

#### Objectives

In this section, students will ...

- listen to a dialogue and complete a flow chart
- draw a flow chart based on a troubleshooting guide
- study the zero conditional for giving instructions
- make sentences with *if* from short dialogues
- draw a flow chart based on instructions in a short text
- write a set of instructions for a troubleshooting guide based on information in a dialogue
- complete dialogues with short answers
- practise the dialogues
- make similar dialogues, using different information



## Briefing

This unit deals with **troubleshooting**, that is, identifying and solving problems with systems, setups or equipment. A **user** (of equipment) can obtain **technical support** (or help) by means of **operating manuals** (or **user guides**) and **telephone hotline services**.

### 1 Operation

Section 1 looks at ways of explaining how equipment works and how it is operated, using as an example the **airboard**, a sports/leisure vehicle. The airboard uses the **hovercraft** principle of the **air cushion**. An engine-driven **fan** sucks in air from the front and **thrusts** it downwards, creating a cushion of air enclosed by a **flexible skirt**. This allows it to **hover** a few centimetres above the ground. The fan also provides a stream of air which exits at high speed from the rear of the craft and **propels** the craft forwards, like a hovercraft. To **increase** or **reduce** the airboard's **speed**, you press one of the **levers** on the **handlebar**: this lever controls the speed of the engine and fan. To improve **acceleration** the airboard has a **friction drive wheel** beneath it, at the rear. When you want to **accelerate** forward, you move your body weight backwards slightly so that the friction wheel touches the ground. At the same time, you press the other lever on the handlebar: this engages the friction drive **clutch** and makes the wheel move quickly. This gives a quick burst of acceleration without losing the feeling of hovering above the ground. To turn left or right, you move your body weight slightly left or right while also moving the handlebar down slightly. The airboard has a top speed of 25 km/h. To stop the airboard you simply **release** both levers and the board slows down and stops. The fuel tank can hold approximately 5 litres of petrol.

### 2 Hotline

Section 2 deals with computer technical support provided to customers over telephone hotlines. Hotline technicians often ask the customer to switch on their computers so that they can go through all the steps one by one with the customer (*I'll talk you through it*), checking at each stage what the customer sees on the screen. The customer on page 70 is having problems with their **Wi-Fi hub**. This is a device that combines the functions of a **modem** and a **router**. The modem function of the hub **converts** the signal from the **cable** in your street into a **signal** that your local devices can use – it brings the internet into the building. The router function of the hub **distributes** the signal to all the devices in the building. It can do this both by cable and by Wi-Fi. However, if the Wi-Fi from the hub cannot reach all the devices in the building (perhaps because the building is too large), one option is to use a **powerline adapter**. This device plugs into any **power outlet**. A cable from the hub to the powerline adapter

(the blue cable in the diagram in 3) sends the signal through the electric wiring system to any room in the building. In another room, a second powerline adapter plugged into a power outlet captures the signal from the electrical wiring and transfers it to the device, for example by ethernet cable to a computer or by Wi-Fi to a mobile phone or other device. The correct **setup** (arrangement) of the hub is shown in the diagram in 3. The diagram in 8 on page 71 shows the wiring diagram of a **home theatre** setup which connects together a **smart TV**, an **AV amplifier**, a **Chromecast dongle** (small plug-in device) and a **games console**. In the *Extra material* on page 117, the diagram shows the TV connected via the AV amplifier to a Blu-ray player and **external speakers**.

### 3 User guide

Section 3 deals with troubleshooting flow charts and user guides. A **flow chart** is a diagram which shows the stages in a **process** or an **algorithm**. An example of a flow chart is shown on page 81 (Review Unit E). An **LED** (light-emitting diode) is a semi-conductor diode which glows when an electrical current is applied. LEDs are widely used to show that equipment is on, and other functions.

#### Further reading online

Enter these search suggestions to find out more about the topics below:

**airboards:** *airboard arbortech*

**how hovercrafts work:** *explainthatstuff how hovercraft work*

**how routers and modems work:** *howstuffworks modem router difference*

**how powerline adapter works:** *how powerline adapter works*

**flow charts and algorithms:** *flowchart wiki*





## Teacher's notes

### 1 Operation

#### Start here

- 1 Put students in pairs. Ask them to look at the photo. Tell students that the man is riding an airboard. Tell them to discuss with their partner how they think that the vehicle moves.
- 2 Ask students to look at the photo again and to match each numbered part with its function in the chart. They can then compare their answers with a partner, but do not confirm answers at this stage. Tell students that you pronounce *levers* /'li:vəz/.

#### Listening

### 3 9.1

Play the recording for students to check their answers to 2. Then ask individual students to read out full answers, e.g. *The engine drives the fan.*

| Part              | Function                             |
|-------------------|--------------------------------------|
| 2 (the engine)    | drive the fan                        |
| 4 (the fan)       | pull the air in + force the air down |
| 1 (the levers)    | control the speed and acceleration   |
| 5 (the handlebar) | steer the airboard                   |
| 3 (the body)      | support the rider                    |

### 9.1

**A:** Look at the airboard. You can see the five main parts: the body, the engine, the fan, the handlebar and the two levers. The body supports the rider and the engine drives the fan. The handlebar steers the airboard left and right.

**B:** Ah yes, I see. So, what does the fan do?

**A:** It pulls the air in and forces it downwards.

**B:** Right. And what do the two levers do?

**A:** They control the speed and acceleration of the airboard.

- 4 Tell students to look at the dialogue, which comes from the recording, and point out the note in the margin. You could either play the recording again for students to complete the dialogue, or ask students to try to complete it first and then listen to the recording to check. Tell them to look back at the chart in 2 to help them.

1 supports 2 drives 3 steers 4 does 5 do 6 pulls  
7 forces 8 do 9 do 10 control

## Language

### Present simple third person singular and plural

Go through the language box with the class, which revises the present simple questions and affirmative forms for the third person singular and plural. Remind students of the work they did on functions in Unit 3 on page 23. Tell them that you use the questions *What do/does ... do?* to ask about how something works.

Remind students that in the third person singular you use *does not do* in questions, and that you add an *s* to the verb in affirmative sentences.

Tell students that they'll find more information about the present simple in the *Grammar summary* on page 101 of the Course Book.

- 5 Students practise asking and answering *Wh-* and *Yes/No* questions, using the present tense. Ask students to make short dialogues about the parts of the airboard. Go through the example with the class so that they know what to do. Remind them to use the same auxiliary in the short answers as in the question.



## Reading

- 6 Ask students what a hovercraft is and ask them to try and explain how it works. Then ask students to read the article which explains how the airboard works and answer the questions. They can then check their answers with a partner.

Ask students to find the verb in the text which means to take your hands off the levers (*release* /rɪ'li:s/). You could then get students to label the skirt, the body, the fan, the handlebar and the levers in the diagram of the airboard.

- 1 It accelerates the airboard into the air.
- 2 It's below the body. It's made of rubber. Yes, you can bend it.
- 3 The rider stands on the fibreglass platform.
- 4 The airboard stops.
- 5 It means *push*.
- 6 (1) forwards (line 12); (2) downwards (line 11)

## Language

- 7 Ask students to read the first sentence. Tell them to underline the infinitive in the sentence (to steer). Explain that this is the infinitive of purpose and that you use it when you want to describe the purpose or function of something. (Note that students often make the mistake of adding *for*, e.g. ~~The purpose of the handlebar is for to steer the airboard.~~) Tell them that purpose, function and job mean the same thing.

Go through the example with the class. Explain that they have to rewrite each of the sentences changing them into the present simple, and beginning the sentences with a part of the airboard.

- 1 The handlebar steers the airboard.
- 2 The levers control the speed of the airboard.
- 3 The friction wheel accelerates the airboard.
- 4 The fan and the engine propel the airboard forwards.
- 5 The skirt holds the air and supports the airboard.
- 6 The body and the platform support the rider.

## Vocabulary

- 8 Ask students to look at the pictures and match them with the sentences.

1 D 2 A 3 B 4 C

- 9 Ask students to complete each sentence with a phrase from the box.

- 1 suspended from
- 2 mounted on
- 3 connected to
- 4 attached to

### Extra activity

Ask students to find things in the classroom that are attached to, connected to, mounted on and suspended from and make sentences.



## 2 Hotline

### Listening

#### 1 9.2

Ask students to look at the photos and to tell you what the function of an automated phone message is. (It's to connect you to the correct department in a company.) Then ask them what the automated message will tell you to do. (Press keys on your phone in order to get through to the correct department and the right person.) Tell them to listen to the message and write down the three numbers that the caller needs to press on his phone to talk to the service technician about his computer problem.

The customer presses key numbers 2, 3, 6.

#### 9.2

Thank you for calling New Tech. For the sales department, press 1. For the service department, press 2.

This is the service department. For computers, press 3. For printers, press 4.

This is the computer unit. To hear information about our services, press 5. To speak to a service technician, press 6.

#### 2 9.3

Tell students that the caller is now speaking to the service technician. Play the recording for them to complete the dialogue. Then play the recording again, pausing to allow students to repeat the phrases. You could then ask students to practise the dialogue, using information about themselves.

1 reached 2 speaking 3 can 4 help

#### 9.3

Hello, you've reached the computer service hotline. This is Jan speaking. I'm the technician. How can I help you?

#### 3 9.4

Ask students to look at the picture. Tell them that the caller is having problems setting up his Wi-Fi hub. Play the recording for students to delete the wrong words in the two sentences.

- 1 The hub isn't connected to the cable socket.
- 2 The customer hasn't connected the powerline adapter to the hub.

#### 9.4

[C = Customer; ST = Service technician]

- C:** Hello, is that the IT hotline?  
**ST:** Yes, it is. I'm the technician. My name's Sofia. How can I help you?  
**C:** I've got a problem with my Wi-Fi hub. It doesn't work.  
**ST:** OK. I'll talk you through it. Are you looking at the hub now?  
**C:** Yes, I am.  
**ST:** OK. Look at the back of the hub. Is the hub connected to the power outlet?  
**C:** Yes, it is.  
**ST:** OK. And is the hub connected to the cable socket on the wall? That's the white cable.  
**C:** Ah ... no, it isn't.  
**ST:** So, connect the hub to the cable socket on the wall now. ... Have you done that?  
**C:** Yes, I have. I've connected it.  
**ST:** OK. Now, have you connected your powerline adapter to the hub? That's the blue cable.  
**C:** Erm ... no, I haven't.  
**ST:** OK. Do it now. ... Have you done that?  
**C:** Yes, I have.  
**ST:** OK. Now let's look at the LEDs ...

### Speaking

- 4 Put students in pairs. Tell students to look at the dialogue and point out the useful language box in the margin. Tell students that they should practise similar conversations based on the setup in 3, using their own names and adding the equipment from the illustration. Tell them to sit back to back when making the telephone call so that they can't see each other when they're speaking.
- 5 Put students in pairs. Ask them to look at the two situations in the illustrations and to make more telephone conversations like the one in 4 about them.

## Language

- 6 In this exercise, students practise giving short answers, using the correct auxiliary verb. Ask students to read the questions and write the *Yes/No* answers. Tell them to do this exercise very quickly. You could turn this into a race, asking students to call out when they have finished the exercise.

- 1 Yes, they are. / No, they aren't.
- 2 Yes, it is. / No, it isn't.
- 3 Yes, I have. / No, I haven't.
- 4 Yes, it does. / No, it doesn't.
- 5 Yes, I did. / No, I didn't.
- 6 Yes, you can. / No, you can't.
- 7 Yes, I do. / No, I don't.
- 8 Yes, I am. / No, I'm not.
- 9 Yes, they do. / No, they don't.
- 10 Yes, it has. / No, it hasn't.

7  9.5

Ask students to look back at 6. Tell them that you're going to play the recording of the questions and that they'll hear only one answer for each question. Play the recording, pausing after each answer for students to repeat the question.

- |                   |                   |
|-------------------|-------------------|
| 1 Yes, they are.  | 6 Yes, you can.   |
| 2 No, it isn't.   | 7 Yes, I do.      |
| 3 Yes, I have.    | 8 No, I'm not.    |
| 4 No, it doesn't. | 9 No, they don't. |
| 5 No, I didn't.   | 10 Yes, it has.   |

 9.5

- 1 **A:** Are the lights on?  
**B:** Yes, they are.
- 2 **A:** Is the computer connected to the adapter?  
**B:** No, it isn't.
- 3 **A:** Have you sent the email?  
**B:** Yes, I have.
- 4 **A:** Does your new Wi-Fi hub work?  
**B:** No, it doesn't.
- 5 **A:** Did you go to the cinema yesterday?  
**B:** No, I didn't.
- 6 **A:** Can I speak to your brother?  
**B:** Yes, you can.
- 7 **A:** Do you work in the city?  
**B:** Yes, I do.
- 8 **A:** Are you sitting at the computer now?  
**B:** No, I'm not.
- 9 **A:** Do those speakers cost a lot of money?  
**B:** No, they don't.
- 10 **A:** Has your car broken down?  
**B:** Yes, it has.

## Task

- 8 Put students in pairs. Ask Student A to turn to page 117. Tell students that they have the same diagram, but that the setup for the wiring is different. Tell them that they mustn't show their partner their diagram. Refer them to the useful language box where they will find words they need for the different parts of the equipment and questions they can use to find out the differences between their wiring systems.

*Possible answers:*

- Student B has a satellite dish; Student A has no antenna or dish
- Both A and B have an AV amplifier
- Both A and B have a Chromecast inserted in the TV
- A has a Blu-ray player but no games console; B has a games console but no Blu-ray player
- B has a powerline adapter; B's TV and Chromecast receive Wi-Fi from the powerline adapter
- A has no powerline adapter; A's TV is close to the hub and receives Wi-Fi through an ethernet cable from the hub
- A has speakers connected to the AV amplifier; B has no speakers
- A and B use HDMI cables to connect devices to and from the AV amplifier

### 3 User guide

#### Start here

##### 1 9.6

Ask students to tell you how to start up their computer. Then tell them to read the two sentences in the note pad and ask them to look at the flow chart. Explain that the flow chart is based on the information from the notes. It's organised into a simple instruction, a question and answer, and a solution to a problem. Play the recording for students to complete the flow chart.

- 1 Press the power button.
- 2 Does the computer start?
- 3 Check the green LED.

##### 9.6

- A:** Press the power button.  
**B:** OK. I'm pressing it.  
**A:** Does the computer start?  
**B:** No, it doesn't.  
**A:** Check the green LED.

#### Reading

- 2 Ask students to read the troubleshooting guide for a service technician on how to start a notebook computer. Tell them to use the information in the guide and draw a similar flow chart for the computer to the one in 1.

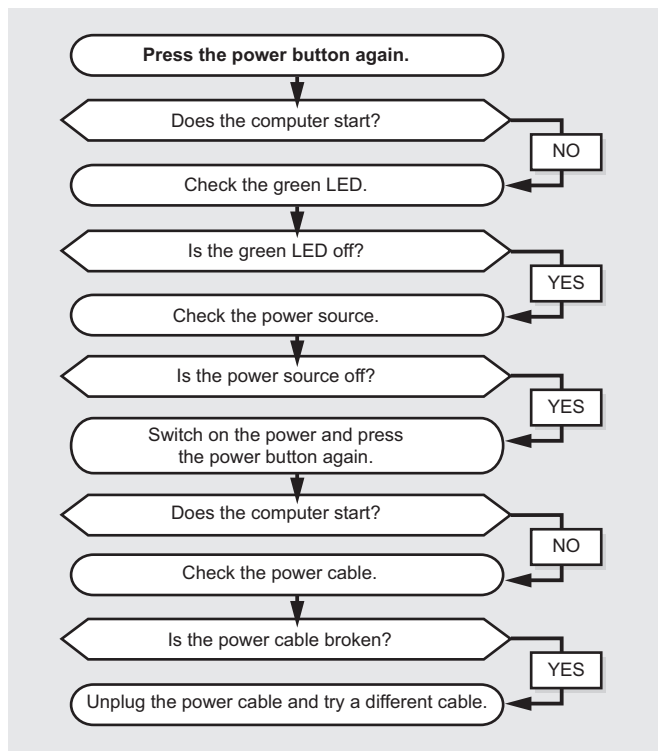

### Language

#### Zero conditional + imperative

Go through the examples in the language box on the zero conditional. Remind students that in zero conditional sentences, you use the present simple in the conditional clause, but in this case, because you're giving instructions, you use the imperative in the result clause, i.e. the bare infinitive with no subject, e.g. *If the light is off, press the power button.* Also remind the student that they must always use a comma after the conditional clause.

Tell students that they'll find more information showing all forms of the zero conditional in the *Grammar summary* on page 104 of the Course Book.

- 3 Ask students to read the first dialogue and the example at the bottom. Make sure that they know what to do. If necessary, do the second dialogue with them as a class. They then make zero conditional sentences from the rest of the dialogues. They can then compare their answers with a partner before you check with the class.

- 1 If the light isn't on, press the switch.
- 2 If the airboard doesn't start, turn the key.
- 3 If there aren't any numbers on the screen, press the keys.
- 4 If the LEDs are off, push the power button.
- 5 If the battery is flat, either replace it or recharge it.
- 6 If the speakers work, connect them to the computer.

- 4 Ask students to read the information from the text. Tell them to draw a flow chart for a service technician's guide, using the information in the text. Point out that the first part of the flow chart is shown in the margin and elicit from the class what goes in the next part of the flow chart. You could draw the flow chart from the answer key without the text on the board, then write the first two parts of the text in the flow chart and ask them to continue with the rest of the flow chart.

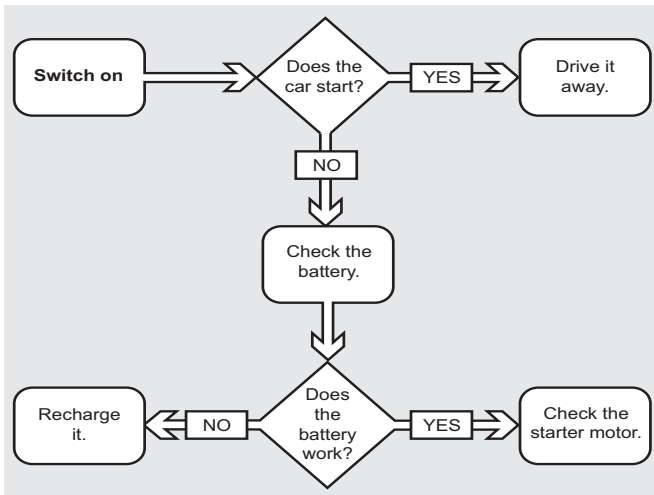

- 7 Put students in pairs to practise the dialogue in 6.  
8 Put students in pairs. Tell them to make similar dialogues to the ones in 6, using the new information.

#### Extra activity

You could ask students to stand up and walk round the room asking other students similar questions to the ones in 6.

### Writing

- 5 Ask students to read the dialogue and the examples below. Remind them of the sentences they wrote from the short dialogues in 3. Then ask them to write a troubleshooting guide based on the dialogue. Point out that they should write six sentences. Tell them to look back at the troubleshooting guide for notebook computers in 2 to help them.

- 1 If you can't print, check the cable between the printer and the computer.
- 2 If the cable is loose, connect the cable.
- 3 If the printer isn't on, check the power.
- 4 If the printer isn't printing, check the paper.
- 5 If there isn't any paper, put some paper in the printer.
- 6 If the printer doesn't print, switch it off and wait for ten seconds. Then switch it on again.

### Social English

- 6 Ask students to write the short form answers to the questions in the dialogue as quickly as they can.

- 1 Yes, I do.
- 2 No, I don't.
- 3 No, I'm not.
- 4 Yes, we have.
- 5 No, I didn't.

## Contents

### 1 Rules and warnings

#### Objectives

In this section, students will ...

- make a list of safety rules for their own workplace or college
- listen and complete warnings with *don't, might, must, mustn't*
- discuss in pairs why signs have different colours and shapes
- read a text and match examples with signs
- study the imperative and a modal verb
- complete the instructions with *always, never, do, do not, must, mustn't*
- write sentences for the instructions in the signs, using *might* or *could* to express possible result
- complete warnings using *there's/there are, could/might*

### 2 Safety hazards

#### Objectives

In this section, students will ...

- listen and match warnings with pictures
- listen and match the warnings with possible results in a table
- say the warnings from the listening and their possible results from the table
- make a list of safety hazards in the picture of an automotive workshop, in pairs
- describe the hazards in the picture
- study the past simple of *is* and *are*
- change sentences about the hazards in the picture into the past
- complete a safety inspection report describing the hazards in the workshop, using the past simple
- write ten safety rules or more in a group about the workshop in the picture

### 3 Investigations

#### Objectives

In this section, students will ...

- discuss what's happening in a picture
- listen and complete a dialogue between a pilot and air traffic control giving a warning with numbers
- complete an incident report with details from a newspaper account of a near miss between two planes
- in pairs, take roles as an investigator or a pilot and ask and answer questions about the near-miss incident, using *Where? When? How high? What? How far? How many?*
- study language for asking and answering questions in the past. *It was ..., It happened ...*
- in pairs, investigate two accidents in the workplace, by asking and answering questions about them and completing the accident reports
- complete phrases in a dialogue for inviting, accepting, and turning down an invitation
- practise the dialogue
- make similar dialogues with a partner with different times and days

# Briefing

This unit deals with ways of communicating about health and safety at work.

## 1 Rules and warnings

Sections 1 and 2 deal with safety **rules** (normally written down), safety **signs** (or symbols) and spoken (or shouted) **warnings**. Safety clothing and personal equipment include a **hard hat** (or safety helmet), **safety gloves**, **safety boots**, **safety goggles** (to protect the eyes) and **overalls** (clothing to cover the complete body). Other safety equipment found in a workshop includes a **guard** (to cover dangerous parts of a machine), a **fire extinguisher** (to put out fires) and warning **cones** (usually red and white plastic cone-shaped objects, placed around dangerous items or holes at ground level). All buildings require a **fire exit** (for staff to leave the premises quickly in a fire), which must be unlocked and easy to access.

## 2 Safety hazards

It is sometimes necessary to explain the reasons for safety rules in order to persuade less experienced staff to follow them. This is why a spoken warning often takes the form *warning + explanation*, for example, *Don't touch that wire! You might get an electric shock*. Common expressions explaining dangers include *get a(n electric) shock*, *injure (tr)*, *hurt (tr)*, *damage (tr)*, *burn (tr)*, *trap (tr)* (Example: *trap your hand in the gears*), *fall (intr)*, *fall over (intr)*, *fall into (a hole or gap)*, *fall over (some bricks)*, *trip (intr)*, *trip up (intr)*, *trip over (a cable on the ground)*.

The **ISO** (see page 108) international standard safety signs illustrated in this unit follow a standard pattern. **Warning** signs (triangular + yellow and black) give a warning about a **hazard** or **danger**, such as *fire risk* or *high-voltage electricity*. **Prohibition** signs (circular + red, white and black with a diagonal red line through the picture) **prohibit** an action, that is, they tell people NOT to do something, for example, *Do not smoke here*. **Mandatory** signs (circular + blue and white) tell people that they **MUST** do something, for example, *You must wear boots here*.

## 3 Investigations

Section 3 deals with communicating about **near-miss incidents** (in which accidents almost happen, but do not actually lead to damage, injury or death). At work it is essential to report not only actual accidents but also near-miss incidents. There are usually lessons which can be learned from these incidents, and **investigations** into them usually lead to changes in workplace procedures so that accidents can be prevented in future. Near-miss incident reporting is especially important in transport industries such as **aviation**, **road** and **rail** transport and **shipping**. The near-miss incident described on page 78 in which an airliner almost landed on top of four other aircraft on the same **runway** is based on an actual event at San Francisco International Airport. The dialogue in 2

illustrates the special language used between pilots and air traffic controllers. *ConAir 286* is the name of the flight. If something is at *twelve o'clock* it is straight ahead, at *one o'clock* means a little to the right, and so on. *Negative contact* means there is no radio contact between the two planes. *Request vectors* means the pilot is asking for instructions where to fly. *Heading* means the direction (given in degrees). *All clear* means there is no more danger. *Resume own navigation* tells the pilot to continue flying without further instructions from air traffic control.

### Further reading online

Enter these search suggestions to find out more about the topics below:

**workplace safety:** *hse health safety work*

**sample incident and injury report form:** *hse forms incident*

**safety signs:** *hse safety signs*

**near-miss aviation incident:** *near miss san francisco airport*



## Teacher's notes

### 1 Rules and warnings

#### Start here

- 1 Put students in pairs. If students work, pair them up with someone who works at the same workplace. Tell them to discuss the safety rules for their workplace or for their college and make a list of these rules. Tell them to keep this list for later in the lesson.

#### 2 10.1

Ask students to read the six warning sentences first. Then play the recording for students to complete the warnings with the words in the box.

Elicit the answers from students. Say: *I don't want to wear a hard hat on the building site. Is it OK?* and elicit the answer to the first question. (*You must wear a hard hat on the building site.*) Do the same for the other questions, e.g. *I want to go through that door. (Don't go through that door!)*.

Ask students: *Is it certain that you get an electric shock with high-voltage electricity?* and elicit *You might* to mean that it's a possible result of the danger.

1 must 2 Don't 3 must 4 Don't 5 might 6 mustn't

#### 10.1

- 1 You must wear a hard hat on the building site.
- 2 Don't go through that door!
- 3 You must wear safety gloves everywhere in the factory.
- 4 Don't touch that machine! It's very hot.
- 5 Be careful! High-voltage electricity. You might get an electric shock.
- 6 You mustn't use your mobile phone here.

#### Reading

- 3 Put students in pairs. Ask students to look at the warning signs in the text at the bottom of the page. Elicit the names of the shapes (*circle* and *triangle*). Ask them to discuss why they think that the signs have different colours and shapes. Do not confirm answers at this stage.
- 4 Ask students to read the text and check their answers to 3. Point out that *triangular* and *circular* are adjectives and *triangle* and *circle* are nouns. Write circle → circular and triangle → triangular on the board with the stressed syllables underlined to show that the stress moves on the adjective *triangular*. Point out to students that *circular* means the same as *round*.

Then ask students to match the examples with the signs.

Answer to 3:

They have different shapes to show different meanings: Triangular signs in yellow and black are warning signs. They warn you not to do something.

Round signs in red, white and black are prohibition signs. They tell you that you can't do something.

Round signs in blue and white are mandatory action signs. They order you to do something.

Answers to 4:

1 C 2 E 3 B 4 D 5 A 6 F

## Language

### ***always/never, don't imperatives and modal verbs must/mustn't***

Go through the examples in the language box with students. Explain that these are all ways to express rules and warnings. You can use a positive imperative form: (*Always* + the bare infinitive), e.g. (*Always*) *wear a hard hat here*, a negative imperative: *Never/Don't touch the machine*, or the modal verb *must/mustn't*.

Explain that *Never* means not at any time. Check that students understand that *Always* is the opposite of *Never*, and tell them that these frequency adverbs both come before the imperative.

Explain that you use the infinitive without *to* after modal verbs, e.g. *You must wear safety gloves*. not ~~*You must to wear safety gloves*~~. To make negatives for modal verbs you use *not*, e.g. *You mustn't use your mobile phone here*. not ~~*You don't must use your mobile phone here*~~. Point out that *might* is another modal verb.

Tell students that they'll find more information on other modal verbs in the *Grammar summary* on page 101 of the Course Book.

#### **Extra activity**

Students work with the same partner as in 1. Tell them to write up three of the rules from their list, using *You must* or *You mustn't*, or an imperative form, and to invent one 'false' rule. They then read out their rules to the class and the class guesses which rule is false.

- 5 Ask students to look at the six signs and tell you what types of signs they are. (1, 3, 5 and 6 are prohibition signs and 2 and 4 are mandatory action signs.) Then ask them to complete the instructions for each sign with the words from the box.

1 Never 2 Always 3 Do not 4 must 5 Do 6 mustn't

- 6 Ask students to look at the prohibition signs. Tell them to write instructions for these signs using the imperative.

- 1 Do not smoke here.
- 2 Do not use a mobile phone here.
- 3 Do not run here.
- 4 Do not enter here.
- 5 Do not exit here.
- 6 Do not park here.

Go through the notes about *might* and *could* with students. Remind students that *might* means a possible result of a danger or hazard, and tell them that *could* and *might* mean the same thing. You could mime the effect you would have resulting from the hazards to teach the vocabulary. Tell them that *injure* also means the same as *hurt*. You could also point out that in English *injure* and *hurt* are reflexive verbs: *You might injure/hurt yourself on that machine*.

- 7 Ask students to look at the warning signs in the margin. They then complete the warnings about each one with the words and phrases in the box.

To check the answers, you could divide the class in two. Ask one half of the class to read out the warning and the other half to read out the result.

- 1 could/might
- 2 There's, could/might
- 3 could/might
- 4 There are, could/might

#### **Extra activity**

Ask students to find a warning sign not shown in this unit and write a short text to go with it.

## 2 Safety hazards

### Start here

#### 1 10.2

Write *Be careful!* on the board. Ask students what other phrases they know for *Be careful!*, when you want to warn someone about a danger. (*Look out! Watch out! Take care!*) Pre-teach *mind*. Tell students that when you tell someone to *mind* something, you're also telling someone to be careful, warning them to *look out* (for something) as they might hurt themselves or damage the object. For example, when you say *Mind your head*, you're warning someone to be careful of their head as they might hurt it. Play the recording for students to listen and match the pictures with the warnings.

1 D 2 A 3 C 4 F 5 E 6 B

#### 10.2

- 1 Look out! There's a low beam in front of you.
- 2 Be careful! There are some bricks on the floor.
- 3 Watch out! There's no guard on the gears.
- 4 Mind the gap! There's a gap between the train and the platform.
- 5 Careful! There are bare electrical wires on the wall.
- 6 Look out! The water is very hot.

- 2 Play the recording again and ask students to write the warning number from the recording in the appropriate place in the table.

| Warning | Possible result                        |
|---------|--|
| 6       | You might burn your hands.             |
| 1       | You could injure your head.            |
| 4       | You might fall into the gap.           |
| 2       | You could trip over the bricks.        |
| 3       | You might trap your hand in the gears. |
| 5       | You could get an electric shock.       |

### Speaking

- 3 Go through the example with the class. Ask them to look at Warning 1 from the table in 2 and its possible results, and ask them to look at the picture it refers to in 1 (picture D). They then say the warnings and their possible results. Tell them to use *There's ...* or *There are ...* to give a warning, and to use *could* or *might* to give the possible result. Remind them to start each one with warning phrases like *Look out! Be careful!*, etc.

- 4 Put students in pairs. Tell them to look at the picture of the car workshop. They have to discuss the safety hazards they can see in the picture with their partner and to make a list of the hazards. Remind them of the work they did on countable and uncountable nouns in Unit 7, and that they need to use *There's a/some ...* for singular nouns and uncountable nouns, and to use *There are some ...* for plural countable nouns. You could give them an example to start them off, e.g. *There's some liquid on the floor*. Pre-teach *cone* and *coil*, by drawing a simple picture of a cone on the board and some coiled wire. Tell them that there are at least ten safety hazards.

When they've finished, students can then compare their list with another pair. Don't confirm answers at this stage as they will be checking them in the next exercise.

- 5 Ask students to look at the photo of the man in the margin and say what they think his job is. Then tell them to imagine that they are the safety inspector inspecting the workshop in 4. They have to describe the hazards in the workshop using the words in the box.

Tell students to use the words and phrases in the table to describe the safety hazards they can see in the picture in 4. Point out that the sentences on the left with *There's ...* and *There are ...* describe the hazards in the workshop, and the sentences on the right with the verb *be* and the past participle describe the result of an action. You could remind students of the work they did on this in Unit 8.

When checking the answers, make sure students can find the hazards they missed in the picture in 4.

- 1 There's some liquid on the floor.
- 2 There are some bricks on the floor.
- 3 There are some boxes on the stairs.
- 4 There's some food on the benches.
- 5 There's some drink on the benches.
- 6 There are some tools on the floor.
- 7 There are no fire extinguishers in the workshop.
- 8 There's a fire exit in the workshop.
- 9 There are no cones around the bricks.
- 10 There are no guards on the machines.
- 11 A cable is damaged.
- 12 Two windows are broken.
- 13 The fire exit is locked.

## Language

### Past simple of *is* and *are*

Go through the examples in the language box with the students and explain that the past of *be* is *was* and *were*. You use *was* with *I/he/she/it*, and *were* with *you/we/they*. Ask them to look at the examples in the table and find these sentences in the present simple in the table in 5.

Tell students that they'll find more information on the past simple of *be* in the *Grammar summary* on page 104 of the Course Book.

- 6 Ask students to change the other sentences in 5 into the past as a whole class. Check that they're pronouncing *was* /wɒz/.

## Writing

- 7 Ask students to read the safety inspection report about the workshop in 4. Then tell them to look back at the information in Exercise 5 and complete the report, using the past simple. Tell them to add any more information that they can.

- 1 There were no fire extinguishers anywhere in the workshop.
- 2 There was a single fire exit, but the door was locked with a padlock.
- 3 There was some liquid on the floor.
- 4 There were some bricks on the floor, but there weren't any cones around them.
- 5 There were some boxes on the stairs.
- 6 There was some food and drink on the benches.
- 7 There were some tools on the floor.
- 8 There were no guards on the machines.
- 9 A cable was damaged.
- 10 Two windows were broken.

- 8 Put students in small groups. Tell them to write at least ten safety rules for the workshop in the photo in 4. Remind students about the work they did in 5 of the previous lesson on imperatives, *always*, *never*, *must* and *mustn't*. Point out that they can also write rules with *No* plus the *-ing* form: *No eating or drinking*, etc.

### Extra activity

Ask students to work in small groups and write a list of safety rules for their classroom.

### 3 Investigations

#### Start here

- 1 Put students in pairs. Ask students to look at the picture of the two planes and answer the questions. Go through the answers with the class.

*Possible answers:*

- 1 The planes are going to crash into each other.
- 2 The plane on the left is moving north, and the plane on the right is moving south-west.
- 3 The air traffic controller will talk to the pilot.

#### 2 10.3

Ask students to look at the diagram of the clock in the margin and explain that clock references are used to give the relative location of planes. Ask them what the position of the blue plane is to the red plane (*Two o'clock*). Tell students that they're going to listen to the air traffic controller warning one of the pilots in the picture about the danger his plane is in. Play the recording for students to complete the dialogue.

Ask individual students to read out their answers. Make sure that they're using single digit numbers for the flight numbers and also for the direction 045 (*oh four five*).

1 Two 2 150 3 right 4 045 5 85 6 045 7 85

#### 10.3

[AC = Air traffic controller; P = Pilot]

**AC:** Air 286. Unknown traffic. Two o'clock. 150 metres. Crossing right to left.

**P:** Air 286. Negative contact. Request vectors.

**AC:** Turn right. Heading 045. Descend. 85 metres.

**P:** Right turn. Heading 045. Descending. 85 metres. Air 286.

...

**CP:** Air 286. All clear. Resume own navigation.

**P:** Roger. Air 286.

#### Reading

- 3 Ask students to look at the heading and the photo and to explain what *near miss* means. Tell students that the newspaper article gives details about the plane incident from the recording. Ask them to read the article quickly and not to worry about any words they don't know.

Ask students what types of planes were in the near miss. Then ask students to look at the incident report and to write the type of plane for the plane under investigation. Go through the other headings in the form and elicit what *altitude* means (the height of the plane above sea level). Tell them to find the information in the newspaper article to complete the rest of the incident form.

#### Aviation near-miss incident report

Date of incident: 7 July

Time: 23:46

Location: above San Francisco Airport, USA

Type of incident: landing at wrong runway

Distance between two planes: 4.3 metres

Number of injuries: none

Passengers at risk: about 1000

#### Plane under investigation

Type: Airbus A320-211 passenger plane

Lowest altitude: 18 metres above runway

Flight number: AC759

Number of passengers: 135

Number of crew: 5

Flying from: Toronto

Flying to: San Francisco

## Speaking

- 4 In this exercise, students practise asking and answering *Wh-* questions in the past simple. Before they start, go through the language box with them. (See below.)
- Put students in pairs. Ask them to decide who wants to be the investigator asking questions about the near-miss incident and who wants to be the witness and answer the questions about it. The investigator then asks the witness questions about the near-miss incident, using the prompts, and the pilot answers the questions, using the information from the incident report form on page 78. Point out that *take place* means the same as *happen*.

- 1 Where did the incident happen?  
(It happened) above San Francisco Airport.
- 2 When did it take place?  
(It took place) on 7th July.
- 3 How high was the Airbus?  
(The Airbus was) 18 metres above the runway.
- 4 What was the correct runway?  
(The correct runway was) number 28R.
- 5 How many planes were on the runway?  
(There were) four (planes on the runway).
- 6 How far was the Airbus from the nearest plane?  
(The Airbus was) 4.3 metres (from the nearest plane).
- 7 What was the flight number of the Airbus?  
(The flight number of the Airbus was) AC759.
- 8 How many passengers were in the Airbus?  
(There were) 135 passengers (in the Airbus).

## Language

### Past simple

Go through examples of the past simple question forms with students. Explain that you form past simple *be* questions with *was* or *were*, and other past simple questions with the auxiliary *did* before the main verb. Point out it's not necessary to repeat the subject and verb in the answer.

Tell students that they'll find more information about questions in the past simple in the *Grammar summary* on page 102 and page 104 of the Course Book.

### Task

- 5 Put students in pairs. Ask Student A to turn to page 115 and read about their incident.
- Ask Student B to look at the report form. Tell them they have to ask Student A questions about their incident and complete the form. Students then swap roles. Ask Student B to turn to page 118 where they will find a report about their incident. Student A asks Student B questions to complete the form on page 79.

### Student A: Report form (Student B's incident)

#### About the accident:

Date: 15th July      Location: Level 1 scaffolding  
Time: 14.46      Height above ground: 10 m

#### Type of accident (tick one box):

- lifted something and injured self
- received an electric shock
- slipped, tripped or fell on the same level
- fell from a height
- other

#### About the injured person:

Name: Pedro Gomez  
Job title: Electrician  
Injury: Small 2 cm burn on right arm

#### Description of accident:

Touched a live wire with his right arm and received a small electric shock.

### Student B: Report form (Student A's incident)

#### About the accident:

Date: 23rd November      Location: 3rd floor of the new building  
Time: 09.38      Height above ground: 20 m

#### Type of accident (tick one box):

- lifted something and injured self
- received an electric shock
- slipped, tripped or fell on the same level
- fell from a height
- other

#### About the injured person:

Name: Gino Petri  
Job title: Builder  
Injury: Cut his leg.

#### Description of accident:

He tripped over a metal girder and fell from the 3rd to 2nd floor into a safety net. A girder cut his leg.

## Social English

- 6 Ask students to complete the dialogue with the words in the box.
- 1 must 2 I'd 3 Are 4 can't 5 don't 6 I'll
- 7 Put students in pairs to practise the dialogue in 6.
- 8 In the same pairs, students make similar dialogues, changing the times and the days. They can then go on to make further dialogues using activities of their own choice.

# Review Unit E

## Answer key

- 1**
- |                         |          |
|-------------------------|----------|
| 1 supports; pushes      | 4 steers |
| 2 rotate; move; propels | 5 turns  |
| 3 control; increases    |          |
- 2**
- |        |          |        |            |         |
|--------|----------|--------|------------|---------|
| 1 work | 2 drives | 3 suck | 4 contains | 5 moves |
|--------|----------|--------|------------|---------|
- 3**
- |                 |                |
|-----------------|----------------|
| 1 on the left   | 4 to the right |
| 2 in the centre | 5 below        |
| 3 between       | 6 above        |
- 4**
- |                |                     |
|----------------|---------------------|
| 1 AV amplifier | 4 Wi-Fi hub         |
| 2 battery      | 5 satellite dish    |
| 3 HDMI cable   | 6 powerline adapter |
- 5**
- |                             |                                  |
|-----------------------------|----------------------------------|
| 1 suspended from            | 4 disconnected from              |
| 2 connected to              | 5 attached to;<br>suspended from |
| 3 attached to/mounted<br>on | 6 mounted on                     |

- 7** If the radio doesn't work, check the adapter.  
If the adapter isn't connected, connect it to the radio.  
If the adapter is connected, check the LED.  
If the LED isn't on, check the power switch.  
If the LED is on, press the START button.

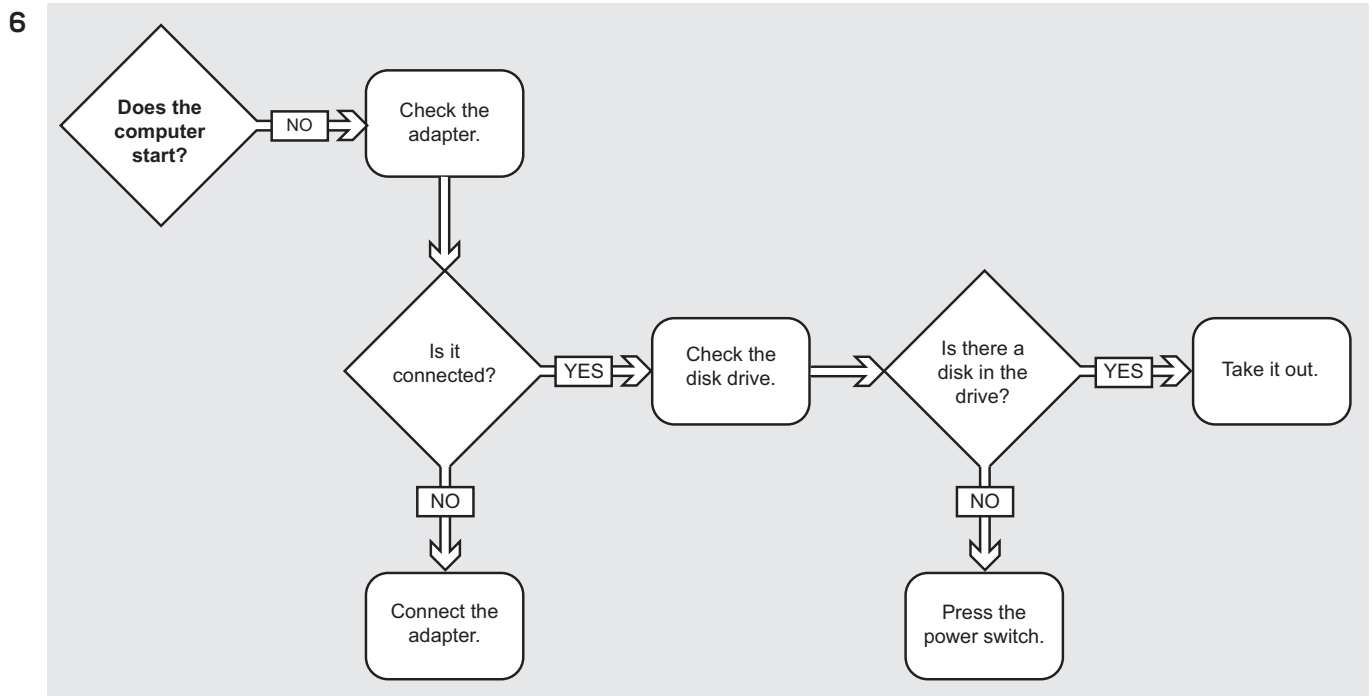

- 8** 1 must 4 could/might  
2 never 5 Always  
3 mustn't 6 might/could; don't

- 9** 1 found 9 told 16 switched off  
2 was 10 took place 17 switched  
3 were 11 put on 18 touched  
4 were 12 climbed 19 wasn't  
5 had 13 was 20 was  
6 didn't wear 14 had 21 was  
7 was 15 shouted 22 didn't receive  
8 were

- 10** 1 Where did the incident take place?  
2 When did it happen?  
3 Did the repair technician wear a hard hat?  
4 How did he climb to the cable?  
5 How high was the cable?  
6 What was the problem?  
7 Did he get an electric shock?  
8 Was the cable connected to the mains supply?

- 11** 1 The emergency exit must not be locked.  
2 Never leave ropes on the ground.  
3 Check fire extinguishers work every week.  
4 Always wear hard hats, safety boots and safety gloves.  
5 Don't coil high-voltage cables.  
6 Never leave tools on the ground.

## Projects

- 12** At the end of every Review Unit is a project. Students can do their research on the internet or in a library, and in their own language if they wish. They must then write their results in English.

## Quick test answer key

### Part 1: Vocabulary and grammar

- 1** 1 steers 4 control 7 triangular  
2 increases 5 attached to  
3 turns 6 connected to

- 2** 1 c 2 e 3 d 4 b 5 a

- 3** 1 supports 3 starts, stops  
2 move 4 protect

- 4** 1 's 2 was 3 aren't 4 's 5 weren't

- 5** 1 Yes, they are. 4 Yes, you can.  
2 No, he hasn't. 5 No, he didn't.  
3 No, it doesn't.

- 6** 1 If the green light isn't on, check the cable is connected to the printer.  
2 If the cable is damaged, replace it with a new one.  
3 If the gears don't have a guard on them, put a guard on the gears.  
4 If the computer doesn't start, check the power source and press the power button.

- 7** 1 Always wear 4 Don't enter  
2 could/might trap 5 must lock  
3 mustn't smoke

- 8** 1 What happened?  
2 Where did the accident take place?  
3 When was the accident?  
4 How many passengers were on the train?  
5 Did you see the accident?

## Part 2: Reading and writing

### Reading

- 1 the basket  
2 the flames  
3 the rope  
4 The wind  
5 the blast valve

### Writing

- 1 There was some oil on the floor.  
2 There were no fire extinguishers.  
3 Two windows were broken. / There were two broken windows.  
4 The doors were locked.  
5 There was no guard on the machine.



# Review Unit E | Quick test

Total \_\_\_\_\_/50

## Part 1: Vocabulary and grammar

### 1 Choose the correct word to complete the sentences.

- 1 The handlebar *steers/rotates* the bike.
- 2 The accelerator *increases/moves* the speed of the car.
- 3 The driver *propels/turns* the car left.
- 4 The levers *control/push* the speed of the airboard.
- 5 The brakes are *attached to/suspended from* the handlebars of the bike.
- 6 The chain is *connected to/mounted on* the wheels.
- 7 The warning signs are *triangle/triangular* in shape.

(7 marks)

### 2 Match the first half of the sentences 1–5 with their endings a–e.

- |   |                                   |
|---|-----------------------------------|
| 1 Don't burn your hand                      | a) on the beam.                   |
| 2 Careful! you might get an electric shock. | b) the bricks on the floor.       |
| 3 You could trap your hand                  | c) in the hot water.              |
| 4 Don't fall over                           | d) in the machine.                |
| 5 You might injure your head                | e) High-voltage electricity here. |

(5 marks)

### 3 Complete the sentences about skateboarding with the correct form of the verbs in the box.

move protect start stop support

- 1 The board \_\_\_\_\_ the rider.
- 2 The wheels \_\_\_\_\_ the board forwards.
- 3 The rider \_\_\_\_\_ and \_\_\_\_\_ the board with his feet.
- 4 The helmet, knee pads and wrist pads \_\_\_\_\_ the skateboarder from injury.

(4 marks)

### 4 Complete the sentences with the correct form of the present simple or the past simple of the verb *be*.

- 1 Look out! There \_\_\_\_\_ a low beam in front of you.
- 2 There \_\_\_\_\_ some oil on the floor yesterday.
- 3 There \_\_\_\_\_ any guards on these machines. Please put some on them.
- 4 We can't use this fire extinguisher. It \_\_\_\_\_ broken.
- 5 That's good! The computers \_\_\_\_\_ damaged in the fire.

(5 marks)

### 5 Write short answers for these questions.

- 1 Are the lights on?  
\_\_\_\_\_ (✓)
- 2 Has Gavin connected the router to the computer?  
\_\_\_\_\_ (X)
- 3 Does the printer work?  
\_\_\_\_\_ (X)
- 4 Can I help you?  
\_\_\_\_\_ (✓)
- 5 Did he burn his hands?  
\_\_\_\_\_ (X)

(5 marks)

### 6 Rewrite these sentences beginning with *If*.

- 1 Is the green light on? – NO – OK. Check the cable is connected to the printer.  
If \_\_\_\_\_.
- 2 Is the cable damaged? – YES – OK. Replace it with a new one.  
If \_\_\_\_\_.
- 3 Do the gears have a guard on them? – NO – OK. Put a guard on the gears.  
If \_\_\_\_\_.
- 4 Does the computer start? – NO. Check the power source and press the power button.  
If \_\_\_\_\_.

(4 marks)

### 7 Complete these sentences with the words in the boxes.

always could/might don't must mustn't

enter lock smoke trap wear

- 1 \_\_\_\_\_ safety gloves when you use this machine.
- 2 Be careful! You \_\_\_\_\_ your hand on the guard.
- 3 You \_\_\_\_\_ in this building.
- 4 \_\_\_\_\_ this building. It's not safe.
- 5 You \_\_\_\_\_ the door when you leave.

(5 marks)

**8 Write the questions for these answers in the past simple, using the words in brackets.**

1 \_\_\_\_\_?

(happen)

There was a train accident.

2 \_\_\_\_\_?

(accident/take place)

Near the station.

3 \_\_\_\_\_?

(be/the accident)

It was about two hours ago.

4 \_\_\_\_\_?

(passengers/be/on the train)

About 200.

5 \_\_\_\_\_?

(you/see/the accident)?

No, I didn't.

(5 marks)

**Part 2: Reading and writing**

**Reading**

Read the text. What do these pronouns mean?

**Hot air balloons**

Hot air balloons consist of a large bag ('balloon') that holds hot air. You stand in a basket and the balloon propels you through air. The basket is suspended from the balloon

5 by steel ropes and **it** can support up to four people.

In order to inflate the balloon, large fans blow cold air into it. There's a propane gas heater mounted on the basket. It sends red-hot

10 flames upwards into the balloon. **These** heat the air inside the balloon. When the air is hot, the balloon rises. A rope is attached to a vehicle. When the balloon is off the ground, the support crew release **it**.

15 The wind controls the balloon's speed and direction. **This** varies at different altitudes. The blast valve controls the flow of the gas to the burner. You use **it** to change the height of the balloon.

1 it (line 4) \_\_\_\_\_

2 These (line 9) \_\_\_\_\_

3 it (line 12) \_\_\_\_\_

4 This (line 14) \_\_\_\_\_

5 it (line 15) \_\_\_\_\_

(5 marks)

**Writing**

Read the notes from the safety inspector. Then write the Safety inspection report.

Eastgate Repair workshop

Oil on the floor

No fire extinguishers

Two broken windows

Locked doors

No guard on the machine

**Safety inspection report for Eastgate Repair workshop**

**Inspected on 3rd August by J. D. Simmons.**

1 \_\_\_\_\_

2 \_\_\_\_\_

3 \_\_\_\_\_

4 \_\_\_\_\_

5 \_\_\_\_\_

(5 marks)

## Contents

### 1 Pistons and valves

#### Objectives

In this section, students will ...

- use a diagram to explain how to put parts of a spray bottle together and draw arrows on a diagram to show this
- discuss how a spray bottle works in pairs
- match descriptions of four stages of pump cycle with diagrams
- study ways to express results or effects of an action: *to* after *cause, allow*; bare infinitive after *make, let; from + gerund* after *stop, prevent*
- make true sentences about the spray pump using the verbs and structures in the language box
- rewrite sentences with *cause, make, let, allow, prevent* and *stop* structures
- delete the wrong words in a text about piston pumps

### 2 Switches and relays

#### Objectives

In this section, students will ...

- do a quiz to find out which electrical symbols they know or don't know
- listen to eight sounds and name them
- discuss how a PIR motion sensor works, in pairs
- read a web page and label the diagram of the PIR motion sensor
- discuss in pairs Bob's answer to the second question in the text
- read the next part of the web page and check an answer
- answer questions about the text
- complete sentences with *allow, cause, let, make, prevent, stop* to check meaning and structure.
- explain how the burglar alarm works

### 3 Rotors and turbines

#### Objectives

In this section, students will ...

- do a quiz about wind turbines and discuss what students know about them
- listen to a radio programme about wind turbines and check answers to a quiz
- label a diagram with parts of a wind turbine
- read a short description of the location of the different parts in a wind turbine and check answers
- read a web page interview about how a wind turbine works and answer questions
- identify the meaning in the text of the reference words *it* and *one*
- complete sentences with *cause, make* and *prevent*
- explain how a wind turbine works based on the information in the main diagram
- make suggestions with *let's* and *why don't we?*

## Briefing

This unit deals with the relationship between cause and effect, relevant to a wide range of technologies and industries. Specifically, it looks at causation (where an action or device **causes** something to happen), permission (where an action or device **allows** or **permits** something to happen), and prevention (where an action or device **prevents** or **stops** something from happening).

### 1 Pistons and valves

Section 1 deals with **pistons** and **valves**, which are components of **piston pumps**. In this type of pump, the piston moves forwards and backwards (or up and down) inside a sealed cylindrical **chamber** or container. A set of **valves** controls the direction of flow of the fluid: they open and close in such a way that the fluid can only flow through the chamber in one direction. When the piston moves through the chamber, it **increases** the **pressure** on the fluid in front of it and **decreases** the pressure on the fluid behind it. This change of pressure forces the fluid to flow from an area of higher pressure to an area of lower pressure. The changes of pressure also make the valves open or close depending on their location and structure. An **inlet valve** opens to allow fluid into the chamber, but closes to prevent it from flowing back out through the same valve. An **outlet valve** opens to allow fluid out of the chamber, but closes to prevent it from flowing back in.

### 2 Switches and relays

Section 2 deals with **switches** and **relays** in an electrical **circuit**. A switch simply opens or closes a circuit (see Unit 5), and can be operated manually by pressing a button or moving a switch lever. A relay is a more complex type of switch: it is not controlled manually but by an **electromagnet**. An electromagnet consists of an iron **core** (cylindrical bar) with a **coil** of metal wire twisted around it. When **current** flows through the coil around the core, the core becomes a magnet and acts as a switch. A **transistor** can also function as a switch – an **electronic switch**. The diagram in 4 shows how one type of burglar alarm works. A **PIR (passive infrared) sensor** in circuit 1 detects heat from the intruder's moving body and sends a **signal** to the transistor. This closes circuit 2 and allows current to flow to the electromagnet. When current flows around the coil of the electromagnet, the iron core is **magnetised** and pulls the **armature** (a piece of soft iron) towards it. The armature then pushes two **contacts** together, which closes circuit 3 and allows electricity to flow to the **siren** and the Wi-Fi **transmitter**.

### 3 Rotors and turbines

Section 3 deals with **wind turbines**. A **turbine** is a type of generator that converts rotational movement into electrical power. It is similar in principle to the dynamo (see Unit 3). The **rotor** is the rotating part of the turbine. The wind blows and turns the blades, the **blades** make the **shafts** rotate, and the shafts create movement inside the **generator**. Inside the **casing** (or **nacelle**) of the wind turbine, there are two shafts, linked by **gear wheels**. This is because the rotation of the blades is too slow to generate electricity. The **low-speed shaft** (from the blades) is attached to a large gear wheel, and the **high-speed shaft** (to the generator) is fixed to a small gear wheel. The large gear wheel rotates slowly and makes the smaller gear wheel rotate rapidly. The high-speed shaft rotates inside the generator and produces electricity. In the cutaway diagram of the wind turbine on page 88, the **yaw** (or **direction**) **drive** is shown. This mechanism turns the whole nacelle from left to right, controlled by the controller (computer) using data about the wind direction which comes from the vane.

#### Further reading online

Enter these search suggestions to find out more about the topics below:

**pumps:** *internet glossary pumps*

**spray bottle pumps:** *howstuffworks spray bottle*

**electromagnets:** *howstuffworks electromagnet*

**relay switches:** *howstuffworks relay*

**PIR burglar alarms:** *pir burglar alarm circuit*

**wind turbines:** *howstuffworks wind power*

**gears:** *howstuffworks gear*

## Teacher's notes

---

### 1 Pistons and valves

#### Warmer

Ask students to name all the different types of products you can find in spray bottles.

#### Start here

---

- 1 Ask students to look at the picture of the incomplete spray bottle. Tell them to draw arrows from each part to show where they fit into the bottle. They can then compare where they've put their arrows on their spray bottle with a partner. Then tell students to look at the completed spray bottle on page 113 to check their answers.
- 2 Put students in pairs. Tell them to look at the incomplete diagram of the spray bottle in 1 and the completed one on page 113 and discuss with their partner how it works and what each part does. Remind them of the work they did in Unit 5 and revise some vocabulary, e.g. *flow/moves into/ out of*. You could also teach the word *squeeze* for *squeeze the trigger*. Do not confirm answers at this stage, as they will read about how the pump works in the next exercise.

#### Reading

---

- 3 Ask students to look carefully at the four diagrams which show the different stages of the working of a spray bottle. Then ask students to read the captions about how the spray bottle works and to match each of the captions with one of the diagrams. Point out the notes and diagrams about *increase* and *decrease* in the margin.

Caption 1: B

Caption 2: D

Caption 3: C

Caption 4: A

#### Extra activity

Ask students to look back at the captions and find the opposites for *inlet*, *increase*, *close*, *stop* and *flow into*.

## Language

### Verb constructions with *cause, make, let, allow, prevent* and *stop*

Go through the example sentences in the language box with students. Explain that *let* means the same as *allow* (i.e. something can happen), and *cause* means the same as *make* (i.e. force something to happen). The difficulty for students is that you use different verb constructions with these words. Some verbs such as *cause* and *allow* are followed by the object + infinitive, e.g. ... **causes/allows the water to flow out**. Some verbs such as *make* and *let* are followed by the object + infinitive without *to*, e.g. ... **makes/lets the water flow out**. *Prevent* means the same as *stop* (i.e. stop something from happening). *Prevent* and *stop* are followed by the object + *from* and the gerund, e.g. ... **prevents the shaft from moving**. Students will need a lot of practice with these constructions.

- 4 Ask students to look back again at the diagram of the spray pump and tell them to make true sentences about how it works, using the words and phrases in the table. Tell them that they can then look back at the captions in 3 if they need extra help.

#### Possible answers:

The trigger makes the piston move in.

The piston makes the pressure increase/decrease. The spring makes the piston move in and out.

The two valves let the air and water flow in or out.

The two valves allow the air and water to flow in or out.

The (closed) inlet valve prevents the water from flowing back (into the bottle).

The (open) inlet valve lets the water flow out (of the bottle and into the chamber).

The outlet valve stops the air from flowing in.

The closed outlet valve stops the air from flowing in.

The closed outlet valve prevents the water from flowing out.

High pressure causes the outlet valve to open.

Low pressure makes the outlet valve close.

High pressure makes the inlet valve close.

Low pressure causes the outlet valve to close.

Low pressure causes the inlet valve to open.

- 5 Students rewrite each sentence so that it has a similar meaning. They must replace the verbs in italics with the correct form of the verbs in brackets. Tell them they will need to make other changes to the sentences such as adding *to* or *from* and using the gerund instead of the infinitive.

Do an example with the class first. They rewrite the rest of the sentences on their own. They can then compare their answers with a partner.

- 1 Heat makes a metal expand and cold causes it to contract.
- 2 Overflow pipes allow extra water to flow out of the tanks.
- 3 The valve on the oil well prevents the oil from exploding.
- 4 These powerful pumps make the water rise 30 m up the hill.
- 5 These fire extinguishers stop electrical fires from spreading.
- 6 Show your ID card and the guard will let you enter the factory.

- 6 Ask students to look at the illustration of the piston pump and ask them to try and explain how it works. Then ask them to read the text quickly to check their answer. Tell them not to delete the wrong words yet.

Tell students to read the text again and this time to delete the wrong words as they do so. They can then check their answers with their partner before you check with the class.

- |            |               |
|------------|---------------|
| 1 to move  | 7 to flow     |
| 2 to move  | 8 to decrease |
| 3 increase | 9 open        |
| 4 open     | 10 to flow    |
| 5 flow     | 11 to close   |
| 6 to close | 12 to flow    |

## 2 Switches and relays

### Start here

- 1 Put students in pairs. Ask them to look at the electrical symbols. Tell them to match the words with the correct symbol. Tell them to look at page 109 when they've finished, to check their answers.

conductor; lamp; speaker; bell; battery; switch; transistor; earth

### 2 11.1

Ask students to look at the list of sounds. You could allow them to discuss with a partner what things they associate with these sounds. Play the recording for students to identify the sounds. They could then compare their answers with a partner before you check with the class.

1 alarm bell 2 beep 3 buzzer 4 horn 5 dial tone  
6 door bell 7 click 8 siren

### 11.1

- 1 Urgent sound of alarm bell
- 2 Sound of beep in automatic phone
- 3 Sound of buzzer
- 4 Sound of car horn
- 5 Sound of dial tone after picking up phone
- 6 Sound of door bell, ding-dong
- 7 Sound of mouse click
- 8 Sound of siren

### Reading

- 3 Put students in pairs. Ask them to look at the photo and discuss how a PIR motor sensor works. Do not confirm answers at this stage.
- 4 Ask students to read the web page about how a PIR motor sensor works and compare it with their answers to 3. Tell them to add the labels to the diagram of the sensor.

1 sensor 2 battery 3 battery 4 siren  
5 switch 6 conductor 7 switch

- 5 Ask students to discuss the answer to Bob's second question with their partner. Then ask students to tell you their ideas, but do not confirm answers at this stage.

## 6

Ask students to read the next part of the web page about the burglar alarm to check their answer to 5. Tell them to look at the diagram of the burglar alarm system as they do so.

By pulling an armature towards it, which pushes two contacts together and closes Circuit 3.

- 7 Ask students to read the questions about the complete burglar alarm system, and then tell them to quickly find the answers to them in the text. They can then compare their answers with a partner before you check with the class.

- 1 three: Circuit 1 powers the sensor; Circuit 2 powers the electromagnet; Circuit 3 powers the siren and wireless transmitter
- 2 one: an electromagnet is an iron bar with a coil of wire around it; it is magnetic when a current flows in the coil
- 3 three: an on/off switch; a transistor; a relay switch
- 4 the on/off switch is operated by hand; the transistor is operated by a signal from the sensor; the relay switch is operated by the electromagnet

## Language

- 8 This exercise revises the meaning and structure of the verb constructions that students have studied in the previous lesson. Ask students to complete the sentences with the correct form of the verbs in the box. Tell them to look back at the language box on page 85 to help them if necessary, and remind them that *allow* and *cause* are followed by the object + the infinitive, *make* and *let* are followed by the object + infinitive without *to*, and *prevent* and *stop* are followed by the object + *from* + gerund.

- |                  |                  |
|------------------|------------------|
| 1 allow          | 4 stops/prevents |
| 2 prevents/stops | 5 makes          |
| 3 causes         | 6 lets           |

## Speaking

- 9 Put students in pairs. Students try to remember how the burglar alarm works. Tell them to cover the text in 6, but to use the diagram in 4 to help them. If possible, they can draw a circuit diagram for the burglar alarm. Then ask them to explain how it works with their partner. Go round the class, listening to students as they are explaining the burglar alarm system, and making sure that they're using the verb constructions that they've studied correctly.



### 3 Rotors and turbines

#### Start here

- 1 Ask students to look at the photo of the wind turbine. Find out if they have any wind turbines near where they live and what they think about them. Then ask them to read the quiz and answer the questions. Do not confirm answers at this stage.

#### 2 11.2

Play the recording for students to check their answers to the quiz in 1.

1 b 2 c 3 a 4 c

#### 11.2

When the 62 Vineyard Wind 1 turbines are activated in 2023, they will probably be the world's tallest turbines. The plans for the turbines show that the towers of these huge turbines will be about 260 metres tall. They will probably also be the world's most powerful turbines. One spin of a tower's over 100-metre blade could power a home for two days.

But probably the world's highest wind turbines are about 4900 metres above sea level, in the mountainous region of Tibet. The towers of the wind turbines aren't the tallest, but at 4900 metres, they're probably the highest.

Wind turbines start producing power at the minimum wind speed of about 15 kilometres per hour. If the wind speed is less than 15 kilometres per hour, the wind turbine doesn't switch on.

The maximum wind speed for a turbine is about 90 kilometres per hour. If the speed of the wind is more than this, the turbine switches off and the blades stop.

#### Extra activity

You could write up the following questions about the recording on the board for students to answer:

*What country is the highest wind turbine in? (Tibet)*

*Is it the tallest wind turbine in the world? (No, it isn't.)*

*What happens when the wind speed is less than 15 kilometres per hour? (The wind turbine doesn't switch on.)*

*What happens when the wind speed is more than 90 kilometres per hour? (The turbine switches off and the blades stop.)*

### Vocabulary

- 3 Ask students to look at the diagram and label it with the parts of a wind turbine in the box. Point out that they need to use one of the words twice. Do not confirm answers at this stage.
- 4 Ask students to read the text and check their answers to 3. Draw students' attention to the diagram of the rotor. Ask them what verb they use to explain the movement of the rotor (*rotate*). Then write the noun *rotor* and the verb *rotate* on the board, underlining the stressed syllables to show that the stress shifts in the verb.

|         |         |           |             |
|---------|---------|-----------|-------------|
| 1 shaft | 2 gear  | 3 housing | 4 generator |
| 5 shaft | 6 brake | 7 hub     | 8 blade     |

## Reading

- 5 Ask students to read the web page interview about how wind turbines work. Then tell them to quickly find the answers to the questions in the text.

- 1 The large gear.
- 2 The controller collects data about the wind speed. It also prevents the wind from damaging the turbine by switching off the turbine.
- 3 The high-speed shaft.

- 6 Ask students to look at the words circled in the text in 5. Tell them that you can also use *one* like *it* to avoid repeating the noun. Tell them to read the information in the sentences before these words to help them find out what they refer to.

- 1 b 2 b 3 a

## Language

- 7 Ask students to complete the sentences with the correct form of the words in the box. Encourage them to do this exercise quickly.

- 1 makes 2 prevents 3 cause

### Extra activity

Write the correct sentences on the board. Then prompt students to give an alternative for each sentence, using the verbs in brackets:

- 1 The wind makes the blades rotate. (cause)
- 2 The controller prevents the wind turbine from operating in a strong wind. (stop)
- 3 The blades cause the low-speed shaft to rotate. (make)

## Speaking

- 8 Put students in pairs. Tell them to cover the reading text in 5. Tell them to explain how the wind turbine works, using the diagram in 3. Remind them to use the verbs *cause*, *allow*, *make*, *let*, *prevent* and *stop*.

## Social English

- 9 Go through the explanation with the class and tell students that you can use *Let's ...?* to make a suggestion. (*Let's* is the contracted form of *Let us*. The full form is never used when making suggestions.) Tell students that *Why don't we...?* has the same meaning as *Let's*.

Ask students to read the situations and make suggestions. When they've finished, read out each sentence and elicit a suggestion for each one, and reply to the suggestion, e.g. *OK. Great. Good idea. Sorry, I can't. Sorry, I'm busy.*

Students can then pair up and take it in turns to practise making suggestions and giving responses, using the sentences in 9.

## Contents

### 1 Data

#### Objectives

In this section, students will ...

- prepare a TV reporter's questions about the Mars Perseverance rover
- skim read a text about the Mars Perseverance rover to check if their questions were answered
- study ways to express approximation
- complete a specification chart with information from the text, using symbols if appropriate
- complete sentences using the information in brackets and changing approximation symbols into words
- write questions for the answers about the rover, using information from the text
- in pairs, practise asking and answering the questions about the Mars Perseverance rover
- in pairs, one student chooses the correct answer for the questions about Mars, then checks with their partner if the answer is correct

### 2 Instructions

#### Objectives

In this section, students will ...

- make a list of instructions for a player of a video game to give the rover in order to follow a route
- listen and complete a dialogue, using the present continuous, to confirm actions
- confirm actions for a list of instructions in a chart
- listen and complete a dialogue giving and confirming instructions, using the imperative and present continuous
- discuss a question comparing response times of a rover on Earth and Mars
- complete a table giving instructions, confirming instructions and reporting what's happening to practise the language for giving and following instructions
- practise the dialogue about making the rover move
- do a memory test by looking at pictures of an astronaut and vehicles in motion, then, with books closed, recall the direction they travelled

### 3 Progress

#### Objectives

In this section, students will ...

- listen to a conversation between a controller and an astronaut checking the progress of tasks on a space station, then complete the list of tasks with verbs
- find the opposites of words in the text
- listen and complete a dialogue based on a GANTT chart to revise the present perfect, past simple and *will*
- study *yet* in present perfect questions and negatives
- make similar dialogues based on a GANTT chart in pairs
- check a partner's progress based on a GANTT chart by completing a task checklist

## Briefing

This unit deals with ways of checking data, confirming and giving feedback on spoken instructions and checking on progress in a project.

### 1 Data

### 2 Instructions

Sections 1 and 2 look at the Mars Perseverance rover. This is a NASA rover (mobile exploratory robot) which successfully landed on Mars on 18 February 2021 after a journey of over six months following its launch from Earth. The rover is nuclear powered and has an autopilot system which helps it to avoid hazards and an autonomous navigation system to allow faster movement. It has a number of goals for the mission: to find out if there was ever life on Mars; to discover the climate and geology of the planet; and to prepare for human exploration and living on Mars. The rover has a number of tools and instruments to help it achieve these goals, as seen in the following notes, based on data from NASA factsheets and press kits:

- (1) **Mastcam-Z**: a pair of zoomable panoramic cameras; main scientific 'eyes'; can see a fly from the length of a football field; high-resolution video and 3D images, and 360 degree panoramas; help rover operators to drive and position the arm's instruments
- (2) **MEDA**: a weather station; contains sensors to measure wind speed, direction, air pressure, humidity, temperature, solar radiation; camera faces sky; monitors how dust and ice affect sunlight reaching surface; collects data about weather and atmospheric dust on Mars and effect on humans
- (3) **MOXIE**: experiments with converting Martian CO<sub>2</sub> into oxygen, because humans who come to Mars will need oxygen to breathe and also to launch return rockets; the size of a car battery, MOXIE can produce enough oxygen to keep a small dog alive; produces 10 g of oxygen per hour
- (4) **PIXL**: an X-ray spectrometer; on end of robotic arm; aims tiny, powerful X-ray beam at rocks; creates maps of chemicals in rocks; can detect whether rock features are caused by present or past life
- (5) **RIMFAX**: sub-surface ground penetrating radar to analyse layers of Martian surface; can detect water ice deposits underground
- (6) **SHERLOC**: a UV spectrometer; located near PIXL on robotic arm; looks for organic molecules and minerals; collects samples to return to Earth; flashes UV laser over the surface, which emits a different glow depending on organic compounds and minerals; also has a camera (**WATSON**) for microscopic images of rock surfaces
- (7) **SuperCam**: laser micro-imager; looks like an eye on the top of the mast; uses a pulsed laser to study chemistry of rocks and sediment, mineral content and hardness of rocks; heats rock to a very high temperature, creating a bright spark which shows chemical makeup;

can zap with a laser at a target 7 m away; records sound of zaps 4 m away with microphone; the sound helps scientists understand properties of rocks.

An object's **mass** (measured in grams, kilograms, tonnes, etc.) is an *absolute* measure which is not affected by the gravity of a specific planet. An object's **weight** (also measured in grams, kilograms, etc.) is a *relative* measure, which changes if the force of gravity changes. In the task exercise on page 93, the simulated rover on Mars takes 20 minutes to respond to its controller on Earth. This is because a radio wave takes about 20 minutes to travel the distance from Earth to Mars.

### 3 Progress

Section 3 deals with spacewalks. A **spacewalk** (also called **extra-vehicular activity** or **EVA**) is work done by an **astronaut** (or Russian **cosmonaut**) away from the Earth and outside their **spacecraft**. EVAs may be **tethered** (where the astronaut is connected to the spacecraft by a cable, oxygen can be supplied through a tube, and no propulsion is needed to return to the spacecraft) or **untethered**. If an EVA is untethered, the astronaut must have a method of propulsion to allow them to return to the spacecraft.

#### Further reading online

Enter these search suggestions to find out more about the topics below:

**factsheet on Perseverance:** *nasa mars perseverance factsheet*

**more detailed information on Perseverance:** *nasa mars perseverance landing press kit*

**extra-vehicular activity (spacewalks):** *nasa space station spacewalks*

## Teacher's notes

### 1 Data

#### Start here

- 1 Ask students to look at the picture and describe what they can see and what's happening. (The picture shows the Mars Perseverance rover exploring the surface of Mars.)  
Elicit some vocabulary from the picture and from the notes in the margin. Then ask students to look at the diagram of the Mars Perseverance rover in 2 and ask them to think about what the different parts of the robot do.  
Put students in pairs. Tell them that they are TV reporters. They then prepare questions about the Mars Perseverance rover with their partner. Elicit the first question from students to get them started.

#### Reading

- 2 Ask students to look at the diagram of the Mars Perseverance rover and its labelled parts. Tell them to read the text quickly and to tick the questions in their list from 1 that the text answers. Remind them to look at the notes in the margin to help them with vocabulary.

#### Extra activity

Write the following parts of the Mars Perseverance rover on the board and elicit from students what their function is:

- 1 The tool at the end of the Mars Perseverance rover (It drills into the ground and pulls out samples of rock.)
- 2 The mast (It supports two special cameras.)
- 3 The suspension system (It allows the six wheels of the rover to remain on the ground at all times, and for the rover to go over big rocks.)
- 4 The motor in each of the wheels (They allow the vehicle to rotate at 360 degrees.)

## Vocabulary

Ask students to look at the symbols to express approximation. You could then ask students to look back at the text in 2 and underline sentences that include these expressions in the text.

- 3 Ask students to look at the specification chart and the information that they need to find about the Mars Perseverance rover. Then ask them to look back at the text in 2 and quickly find the answers to complete the chart. They can compare their answers with a partner before you check with the class.

- 1 ~ 2.2 m
- 2 ~ 3 m
- 3 > 2 m
- 4 ~ 1025 kg
- 5  $\geq$  59 kg
- 6 6
- 7 < 53 cm
- 8  $360^\circ$
- 9  $\leq$  40 cm
- 10 152 metres per hour
- 11 < 2 kg
- 12  $-120^\circ\text{C}$  to  $85^\circ\text{C}$

- 4 First, revise the adjectives for height, weight and length. Then tell students to complete the sentences with the information in brackets.

- 1 is about/approximately 2.2 m high and about/approximately 3 m long.
- 2 has a mass of more than/over 1000 kg.
- 3 have a mass of at least 59 kg.
- 4 can rotate up to  $360^\circ$ .
- 5 can travel at a speed of up to 152 metres per hour.

## Speaking

- 5 Students write the questions about the Mars rover. Tell them to find the answer to the questions in the text on page 90 first. This will help them to write the question for it.

- 1 What's the rover called?
- 2 How many wheels does it have?
- 3 What are the wheels made of?
- 4 What is the robot arm attached to?
- 5 What is the mast mounted on?/ Where is the mast mounted?
- 6 How high is the rover?
- 7 What does MOXIE do?
- 8 What does SHERLOC do?
- 9 What is the mass of the scientific instruments?
- 10 How fast can the Mars Perseverance rover move?

- 6 Put students in pairs to take turns in asking and answering the questions in 5 about the Mars rover.
- 7 Students practise checking facts by guessing the answers to a quiz about the planet Mars.

Put students in pairs. Student A reads the questions and guesses the answers to the quiz. Student B turns to page 113 where they will find the correct answers to these facts.

Student A then reads out the facts and asks for confirmation by saying *Is that right?* Student B confirms whether their answers are correct by saying *Yes, that's right/correct.* or *No, that's wrong. Change it to ...*

- 1 b 2 a 3 a 4 b

## 2 Instructions

### Revision

Revise directions: move *forwards/backwards*, *rotate*, *turn left/right*, *turn round*, *stop*. You could ask students to stand up and follow your instructions, but only when you say the word *Please* in the instruction.

### Start here

- 1 Ask students to look at the picture of the Mars rover and the route it's travelling. Explain that they're playing a 3D game and must write down a list of instructions to give the rover so that it can move along the same route as the one shown in the picture. You could elicit the first instruction from the class: *Move forwards 200 cm* and write it up on the board.
- 2  12.1  
Play the recording for students to complete the dialogue between the controller and the Mars rover. Explain that *confirmed* means you're following the controller's instructions. Ask them: *What tense is used to confirm your actions and why?* (The present continuous. You use it to talk about something that is happening now.)

1 moving 2 rotating

### 12.1

[P = Player ; R = Rover]

**P:** Move forwards 200 cm.

**R:** Confirmed. I'm moving forwards 200 cm.

**P:** Now rotate 15 degrees to the left.

**R:** Confirmed. I'm rotating 15 degrees to the left.

- 3 Tell students to imagine that they are the rover. Ask them to look at instruction number 1 and the illustration of the rover's movement for that instruction in the picture at the top of the page. Then ask them to look at the confirmation that the rover gives for the instruction. Students complete the rest of the table, confirming their actions. Remind them that when giving instructions you use the imperative and for confirming actions you use the present continuous tense.

- 1 I'm moving forwards 200 cm.
- 2 I'm rotating 15 degrees to the left.
- 3 I'm reversing 300 cm.
- 4 I'm rotating 80 degrees to the right.
- 5 I'm going up the hill.
- 6 I'm rolling down the hill.
- 7 I'm going round to the left of the rocks.
- 8 I'm stopping.

## Listening

### 4 12.2

Tell students that they're going to listen to someone explaining to someone else how you control the Mars Perseverance rover in the video game. Play the recording for students to complete the dialogue. You could then ask them to practise the conversation in pairs with the students taking the part of the rover doing the actions.

1 make 2 move 3 sliding 4 keying  
5 happening 6 isn't 7 moving

### 12.2

**A:** Right. I'll give you an instruction. First, do it. Then confirm what you're doing, OK?

**B:** OK.

**A:** Then confirm what the rover's doing. Is that clear?

**B:** Yes.

**A:** Right. Let's go. First, make the rover move forwards 200 cm.

**B:** OK. I'm sliding my finger upwards on the screen and keying in 200.

**A:** Good. Now what's happening?

**B:** The rover isn't moving.

**A:** Right. Wait five seconds. Now what's happening?

**B:** OK. It's moving forwards now.

## Task

- 5 Put students in pairs to discuss the question.

There is a time delay because of the speed of sound. The reduced response is caused by the time it takes for a radio signal to travel through space. The delay in sending commands to Mars is about 20 minutes.

## Speaking

- 6 Explain that students are going to write some instructions for the Mars Perseverance rover for the video game, and the confirmation of the actions. Tell them that they'll need to use the information in 3 and the notes below the table in 6. Go through the example with the students first. You could ask one student to read out the instruction given by the instructor, and then another student reads out the confirmation of what the rover is doing. Make sure that they know what to do. Then tell them to complete the rest of the table.

- 1 Make the rover move forwards 200 cm. / OK. I'm sliding my finger upwards and keying in 200. / The rover isn't moving. / Now it's moving forwards.
- 2 Rotate 15 degrees to the left. / OK. I'm sliding my finger in a circle to the left and keying in 15. / The rover isn't turning left. / Now it's turning left.
- 3 Reverse for 300 cm. / OK. I'm sliding my finger downwards and keying in 300. / The rover isn't reversing. / Now it's reversing.
- 4 Rotate 80 degrees to the right. / OK. I'm sliding my finger in a circle to the right and keying in 80. / The rover isn't rotating. / Now it's rotating.

- 7 Put students in pairs. Ask them to cover the table in 6. Tell them to practise the dialogues, using the notes in the table in 3. Ask them to take turns to be the instructor and the player.
- 8 Tell students to close their books. Tell them that they have ten seconds to look at the eight pictures. Explain that they have to remember what each object is, and also to remember what directions the objects are moving in. Ask students to open their books and look at the pictures for 10 seconds. Then tell them to turn to page 113 and follow the instructions. They then turn back to page 93 to check their answers.

- 1 The astronaut is moving downwards.
- 3 The car is turning left.
- 4 The helicopter is moving upwards.
- 8 The motorboat is turning right.
- 2 The plane is going forwards.
- 5 The rover is rotating right.
- 7 The rocket is moving upwards.
- 6 The truck is reversing right round the corner.



### 3 Progress

#### Start here

#### 1 12.3

Ask students to look at the photo. Ask them what they think the astronaut is doing. (He's repairing some damage on a space station.) Then tell them that they're going to listen to an astronaut talking about his work on the international space station.

Play the recording once through for students to listen. Then play it again for them to complete the list of tasks in the speech bubble with the verbs in the box.

You could then play it one more time for them to check their answers.

**1** Test **2** Inspect **3** Take **4** Disconnect **5** Remove  
**6** Bring **7** Dismantle **8** Repair **9** replace  
**10** Assemble **11** Attach **12** Connect

#### 12.3

We sometimes have to make many spacewalks outside the space station, just to do one simple repair job. Let me give you an example. A small piece of rock from space has hit an oxygen tank. What do we do?

First, we must test our equipment for the spacewalks. Then, in the first spacewalk, we inspect the damage. We take photographs of the tank and the hole.

After that, we go back into the space station.

There we plan the repair and prepare for the next spacewalk.

In the second spacewalk, we disconnect the pipes from the tank – these pipes carry the oxygen into the space station. We remove the tank. Then we bring the tank into the space station.

Back in the space station, we dismantle the tank. We repair the damage. If this isn't possible, we replace the part.

Then we assemble the tank again.

In the third spacewalk, we attach the tank to the side of the space station and connect the pipes to the tank.

### Vocabulary

- 2** Ask students to look back at 1 and find and underline the opposite of the words listed.

disconnect; dismantle; repair; replace

### Listening

#### 3 12.4

Tell students that they're going to listen to a controller speaking from the control centre who is talking to the astronaut about the repair work he's been doing on the space station.

Ask students to look at the chart in the margin. Point out that today is the 6th of June. Ask them to read the tasks in the chart that the astronaut has been asked to do.

Then ask students: *Has the astronaut done the tasks?* Play the recording for students to check their answer and to complete the dialogue.

**1** done **2** did **3** did **4** repaired  
**5** repaired **6** repairing **7** will

#### 12.4

[C = Controller; A = Astronaut]

**C:** OK, today is the 6th of June, 7 pm in the evening. I'm checking progress on the space station. Have you done the first spacewalk yet?

**A:** Yes, we have.

**C:** Good. When did you do it?

**A:** We did the spacewalk yesterday, on the 5th of June.

**C:** Right. And have you repaired the oxygen tank yet?

**A:** No, we haven't repaired it yet. We're still repairing it.

**C:** When will you finish it?

**A:** We'll complete the job tomorrow morning.

## Language

### Present perfect with yet

Remind students of the work they did on the Present perfect to talk about recent events in Unit 8. Then go through the language box with students. Explain that you use *yet* in questions and negatives in the present perfect to talk about events that are happening up to now, and that it comes at the end of the question or negative. Point out the short answer *No, not yet*.

Tell students that they'll find more information about the present perfect in the *Grammar summary* on page 102 of the Course Book.

## Speaking

- 4 Put students in pairs. Ask them to look at the chart and to find the date for today. Then ask them to make similar dialogues to the one in 3, using the information from the chart. Remind them that you use the past simple for actions that finished in the past. Tell them to take turns to be the controller and the astronaut. Go round the class, checking that students are using the present perfect and past simple correctly. Make notes of any mistakes and go through them with the class after they've finished the activity.

## Task

- 5 Put students in pairs. Ask Student A to turn to page 117. Ask students to read the instructions and look at the example. Student B asks Student A questions to check that they've done the tasks listed and Student A replies, using the information from their chart on page 117. Ask students to look at the example dialogue first and make sure that they know what to do.
- Students then go through the checklist. Student B makes notes on when the task was completed or when it will be completed. After they've completed the task, Student B can check with Student A that they have the correct information.

| Task                               | Y/N? | Notes                     |
|------------------------------------|------|---------------------------|
| Dismantle old water system         | Y    | Completed 4th August      |
| Assemble new water system          | Y    | Completed 6th August      |
| Install water system               | Y    | Completed 8th August      |
| Test equipment for third spacewalk | Y    | Completed 5th August      |
| Take video of damaged nose cap     | Y    | Completed 6th August      |
| Inspect damage to waste tank       | N    | Will complete 9th August  |
| Assemble new robot arm             | N    | Will complete 11th August |
| Attach new robot arm               | N    | Will complete 13th August |

# Review Unit F

## Answer key

- 1**
- |                         |                         |
|-------------------------|-------------------------|
| <b>1</b> makes          | <b>4</b> allows         |
| <b>2</b> lets           | <b>5</b> stops/prevents |
| <b>3</b> prevents/stops | <b>6</b> causes         |
- 2**
- 1** press; makes; go
  - 2** push; causes; stop
  - 3** pull; prevents; moving
  - 4** release; allows; move
- 3**
- 1** rise
  - 2** close; to open
  - 3** from flowing
  - 4** to flow
  - 5** to go down
  - 6** open; to close
- 4**
- increase ≠ decrease  
expand ≠ contract  
bring ≠ take  
low ≠ high  
assemble ≠ dismantle  
inlet ≠ outlet  
less than ≠ more than  
connect ≠ disconnect  
remove ≠ replace  
approximately ≠ exactly
- 5**
- |                          |                |                 |                 |                 |
|--------------------------|----------------|-----------------|-----------------|-----------------|
| <b>1</b> causes          | <b>2</b> pulls | <b>3</b> causes | <b>4</b> closes | <b>5</b> allows |
| <b>6</b> stops/prevents  | <b>7</b> lets  | <b>8</b> allows | <b>9</b> causes |                 |
| <b>10</b> stops/prevents |                |                 |                 |                 |

**7** *Sample answer:*

A hand pump has (consists of) a handle, a nozzle, a spring, a chamber and two ball valves. The nozzle is at the end of the handle (or goes through the handle). The handle is attached to the spring. The spring is in the chamber. There is an outlet at the top of the chamber, and an inlet at the bottom of the chamber. The top ball valve is on the outlet, and the bottom ball valve is on the inlet. The bottom ball valve is attached to the spring.

When you press the handle down into the chamber, the spring pushes the bottom ball valve down into the inlet and closes it. The pressure in the chamber increases.

This makes the top ball valve move up from the outlet, and the outlet opens. The high pressure forces (pushes) the fluid out through the nozzle (or makes the fluid flow out through the nozzle).

When you release the handle, the spring makes the handle rise again. The pressure in the chamber decreases. The spring makes the bottom ball valve move up from the inlet. This opens the inlet, and allows fresh fluid to flow into the chamber.

- 8
- 1 replaced; replace; replaced
  - 2 taken; take; took
  - 3 driven; drive; drove
  - 4 spoken; speak; spoke

11 *Sample answer:*

The function of the dam is to generate electricity. The main parts of the dam are the powerhouse, the generator, the shaft, the tunnel and the inlet. The dam is 111 metres high, 3600 metres long and 980 metres wide at the base. 11,000 m<sup>3</sup> of water can pass through the dam. The reservoir is 132 km<sup>3</sup>. The dam is made of reinforced concrete. The gates open and this allows the water to flow in through the inlet. The water from the reservoir flows through the filter, through the gate and along the tunnel. The water then flows into the blades of the turbine. The blades move the shaft and the shaft turns the generator. The generator makes electricity. The electricity runs through high-voltage cables. The water then flows out.

### Project

- 12 At the end of every Review Unit is a project. Students can do their research on the internet or in a library, and in their own language if they wish. They should draw a simple diagram and label it, make a specification chart, and then write a short description about the project.

### Quick test answer key

#### Part 1: Vocabulary and grammar

- 1
- 1 nose cap
  - 2 joystick
  - 3 degrees
  - 4 pressure
  - 5 brake
- 2
- 1 e
  - 2 d
  - 3 a
  - 4 b
  - 5 c
- 3
- 1 connect
  - 2 assemble
  - 3 repaired
  - 4 replace
- 4
- 1 allows
  - 2 makes
  - 3 prevents
  - 4 lets
  - 5 stops
  - 6 causes
- 5
- |              |                |
|--------------|----------------|
| 1 Turn       | 6 Press        |
| 2 'm turning | 7 'm releasing |
| 3 Look       | 8 'm pressing  |
| 4 'm looking | 9 's happening |
| 5 Release    | 10 is moving   |
- 6
- |                     |                      |
|---------------------|----------------------|
| 1 Have you repaired | 4 When did you order |
| 2 I'm checking      | 5 He replaced        |
| 3 I haven't bought  |                      |

- 7
- 1 He'll ~~finishes~~ the work tomorrow morning.  
He'll finish the work tomorrow morning.
  - 2 ~~Did~~ the astronauts ~~dismantle~~ the oxygen tank yet?  
Have the astronauts dismantled the oxygen tank yet?
  - 3 Is the car ~~move~~ forwards now?  
Is the car moving forwards now?
  - 4 I haven't ~~yet~~ finished repairing the equipment.  
I haven't finished repairing the equipment yet.
  - 5 A: When ~~you completed~~ the job?  
A: When did you complete the job?

## Part 2: Reading and writing

### Reading

- 1 It can change from a helicopter to a plane.
- 2 It operates the tilting mechanism.
- 3 With the rotors in the vertical position, they rotate in opposite directions and the aircraft lifts off.
- 4 The blades and the wings of the aircraft can fold up.
- 5 As military planes, search and rescue, and emergency medical services.

### Writing

#### Subject: Progress check on car

Dear Mr ...

With reference to your car, I've checked the tyre pressure and I've tested the brakes. I haven't checked the oil yet. I'll check it tomorrow. I haven't repaired the right wing mirror yet. I'll repair it this afternoon. I haven't installed the satellite navigation system. I'm waiting for delivery of the system. I'll install it tomorrow.

# Review Unit F | Quick test

## Part 1: Vocabulary and grammar

Total \_\_\_\_\_/50

### 1 Underline the odd word out in each group.

- blade, gear, hub, nose cap, shaft
- forwards, joystick, rotate, reverse, turn
- degrees, height, speed, distance, mass
- pressure, spring, trigger, tube, valve
- battery, brake, circuit, magnet, terminal

(5 marks)

### 2 Match the words of approximation with their symbols.

- |                       |      |
|-----------------------|------|
| 1 at least            | a) > |
| 2 about/approximately | b) ≤ |
| 3 more than/over      | c) < |
| 4 up to               | d) ~ |
| 5 less than/under     | e) ≥ |

(5 marks)

### 3 The words in *italics* are incorrect. Write the correct word.

- If you want to use the mouse, *disconnect* the keyboard to the mouse cable.
- Follow the instructions carefully in the manual to *dismantle* your new computer table.
- You can use the computer now. The technician has *damaged* it.
- If there is no display on the screen, you may need to *remove* the batteries with new ones.

(4 marks)

### 4 Choose the correct word to complete the sentences.

- The suspension system *allows/lets* the vehicle to go over rocks.
- The current *causes/makes* the electromagnet switch on.
- The closed valve *allows/prevents* the water from flowing out.
- This button *lets/stops* you rotate the rover 360 degrees.
- The controller *makes/stops* the wind from damaging the filter.
- The piston *causes/lets* the water pressure to increase or decrease.

(6 marks)

### 5 Complete the sentences with the words in the box in the correct tense.

happen look move press release turn

A: (1) \_\_\_\_\_ the key.

B: Right. I (2) \_\_\_\_\_ the key.

A: OK. Is the engine on?

B: Yes, it is.

A: OK. (3) \_\_\_\_\_ in the mirror. Check there is no traffic. Is that clear?

B: Yes. I (4) \_\_\_\_\_ in the mirror. There isn't any traffic.

A: Right. (5) \_\_\_\_\_ the handbrake and (6) \_\_\_\_\_ your foot down on the accelerator.

B: OK. I (7) \_\_\_\_\_ the handbrake and I (8) \_\_\_\_\_ the accelerator.

A: What (9) \_\_\_\_\_?

B: The car (10) \_\_\_\_\_.

(10 marks)

### 6 Complete the sentences with the words in brackets in the past simple or present perfect.

- \_\_\_\_\_ the car yet? (you / repair)
- \_\_\_\_\_ the lights now. (I / check)
- \_\_\_\_\_ the skateboard yet. (I / not buy)
- \_\_\_\_\_ the parts? (when / you / order)
- \_\_\_\_\_ the battery in the car one month ago. (He / replace)

(5 marks)

### 7 Cross out the mistake. Then write the correct sentence.

1 He'll finishes the work tomorrow morning.

2 Did the astronauts dismantle the oxygen tank yet?

3 Is the car move forwards now?

4 I haven't yet finished repairing the equipment.

5 A: When you completed the job?

B: Yesterday.

(5 marks)

## Part 2: Reading and writing

### Reading

#### How a tiltrotor aircraft works

A tiltrotor aircraft can fly like a plane, but it can also take off and land vertically and hover like a helicopter. The aircraft has two large rotors with three-bladed propellers. A turboshaft engine drives the propellers.

Some of the power from the engines also drives a mid-wing gear box. This gear box operates a tilting mechanism which allows the aircraft to change from a helicopter into a plane. With the rotors in the vertical position, they rotate in opposite directions and cause the aircraft to lift off the ground. As the plane speeds up, the rotors of the propellers slowly tilt forward, and the helicopter changes into a plane.

The blades and the wings of the aircraft can fold up so that they can easily land on ships or be stored in aircraft carriers. They are used as military planes but also for search and rescue and emergency medical services.

Read the text. Then answer the questions below.

1 What can a tiltrotor aircraft do?

---

---

2 What does the gear box do?

---

---

3 How does the aircraft take off?

---

---

4 Why is it easy to land on ships?

---

---

5 What can you use the tilt aircraft for?

---

---

(5 marks)

### Writing

Read the checklist. Then write an email to the customer giving details about the work you've done, and when you'll complete the work you haven't done.

| Task                                |   | Notes                                      |
|-------------------------------------|---|--|
| Check oil                           | X | Tomorrow                                   |
| Check tyre pressure                 | ✓ |  |
| Test brakes                         | ✓ |  |
| Repair right wing mirror            | X | This afternoon                             |
| Install satellite navigation system | X | Tomorrow. – Waiting for delivery of system |

Subject: Progress check on car

Dear Mr ...

With reference to your car, ...

(5 marks)



# Word list

## Unit 1

---

- adapter (noun) **1 Basics, exercise 8**
- amp (A) (noun) **2 Letters and numbers, exercise 9**
- antenna (noun) **1 Basics, exercise 8**
- bolt (noun) **1 Basics, exercise 8**
- cable (noun) **1 Basics, exercise 8**
- Celsius (C) (noun) **2 Letters and numbers, exercise 9**
- chisel (noun) **1 Basics, exercise 8**
- closed (adverb) **1 Basics, exercise 7**
- counter (noun) **2 Letters and numbers, exercise 7**
- degree (°) (noun) **2 Letters and numbers, exercise 9**
- down (adverb) **1 Basics, exercise 7**
- eighth (verb) **3 Dates and times, exercise 1**
- eleventh (verb) **3 Dates and times, exercise 1**
- euro (€) (noun) **2 Letters and numbers, exercise 9**
- Excuse me. (phrase) **1 Basics, exercise 1**
- feet (f) (noun) **2 Letters and numbers, exercise 9**
- fifth (verb) **3 Dates and times, exercise 1**
- first (verb) **3 Dates and times, exercise 1**
- flight (noun) **2 Letters and numbers, exercise 7**
- fourth (verb) **3 Dates and times, exercise 1**
- gallon (gal) (noun) **2 Letters and numbers, exercise 9**
- Good to meet you. (phrase) **1 Basics, exercise 1**
- gram (g) (noun) **2 Letters and numbers, exercise 9**
- Hello. (phrase) **1 Basics, exercise 1**
- in (adverb) **1 Basics, exercise 7**
- inch (in) (noun) **2 Letters and numbers, exercise 9**
- kilogram (kg) (noun) **2 Letters and numbers, exercise 9**
- kilometre (km) (noun) **2 Letters and numbers, exercise 9**
- kilometres per hour (km/h) (noun) **2 Letters and numbers, exercise 9**
- kilowatt (kw) (noun) **2 Letters and numbers, exercise 9**
- left (adverb) **1 Basics, exercise 7**
- listen (phrasal verb) **1 Basics, exercise 6**
- litre (l) (noun) **2 Letters and numbers, exercise 9**
- lower (phrasal verb) **1 Basics, exercise 6**
- metre (m) (noun) **2 Letters and numbers, exercise 9**
- model (noun) **2 Letters and numbers, exercise 2**
- negative (minus -) (adjective) **2 Letters and numbers, exercise 9**
- Nice to meet you. (phrase) **1 Basics, exercise 1**
- ninth (verb) **3 Dates and times, exercise 1**
- nut (noun) **1 Basics, exercise 8**
- off (adverb) **1 Basics, exercise 7**
- on (adverb) **1 Basics, exercise 7**
- open (adverb) **1 Basics, exercise 7**
- out (adverb) **1 Basics, exercise 7**
- pick up (phrasal verb) **1 Basics, exercise 6**
- platform (noun) **2 Letters and numbers, exercise 7**
- Pleased to meet you. (phrase) **1 Basics, exercise 1**
- plug (noun) **1 Basics, exercise 8**
- positive (plus +) (adjective) **2 Letters and numbers, exercise 9**
- pound (£) (noun) **2 Letters and numbers, exercise 9**
- put down (phrasal verb) **1 Basics, exercise 6**
- raise (phrasal verb) **1 Basics, exercise 6**
- read (phrasal verb) **1 Basics, exercise 6**
- revolutions per minute (rpm) (noun) **2 Letters and numbers, exercise 9**
- right (adverb) **1 Basics, exercise 7**
- saw (noun) **1 Basics, exercise 8**
- say (phrasal verb) **1 Basics, exercise 6**
- screw (noun) **1 Basics, exercise 8**
- screwdriver (noun) **1 Basics, exercise 8**
- second (verb) **3 Dates and times, exercise 1**
- seventh (verb) **3 Dates and times, exercise 1**
- sit (phrasal verb) **1 Basics, exercise 6**
- sixth (verb) **3 Dates and times, exercise 1**
- spanner (noun) **1 Basics, exercise 8**
- stand (phrasal verb) **1 Basics, exercise 6**
- start (phrasal verb) **1 Basics, exercise 6**
- stop (phrasal verb) **1 Basics, exercise 6**
- surname (noun) **2 Letters and numbers, exercise 2**
- tenth (verb) **3 Dates and times, exercise 1**
- third (verb) **3 Dates and times, exercise 1**
- thirteenth (verb) **3 Dates and times, exercise 1**
- thirtieth (verb) **3 Dates and times, exercise 1**
- twelfth (verb) **3 Dates and times, exercise 1**
- twentieth (verb) **3 Dates and times, exercise 1**
- up (adverb) **1 Basics, exercise 7**
- volt (v) (noun) **2 Letters and numbers, exercise 9**
- washer (noun) **1 Basics, exercise 8**
- watt (w) (noun) **2 Letters and numbers, exercise 9**
- write (phrasal verb) **1 Basics, exercise 6**

## Unit 2

---

assemble (verb) 2 Assembling, exercise 1

axle (noun) 1 Naming, exercise 2

blue (adjective) 3 Ordering, exercise 5

bolt (noun) 1 Naming, exercise 6

bricks (noun) 1 Naming, exercise 6

deck (noun) 1 Naming, exercise 2

hammer (noun) 1 Naming, exercise 7

helmet (noun) 3 Ordering, exercise 5

large (adjective) 3 Ordering, exercise 5

lever (noun) 1 Naming, exercise 7

loosen (verb) 2 Assembling, exercise 7

medium (adjective) 3 Ordering, exercise 5

nail (noun) 1 Naming, exercise 7

nose (noun) 1 Naming, exercise 2

nut (noun) 1 Naming, exercise 7

pad (noun) 3 Ordering, exercise 5

plate (noun) 1 Naming, exercise 2

pull (verb) 2 Assembling, exercise 7

push (verb) 2 Assembling, exercise 7

put (verb) 2 Assembling, exercise 7

red (adjective) 3 Ordering, exercise 5

screw (noun) 1 Naming, exercise 7

screwdriver (noun) 1 Naming, exercise 7

small (adjective) 3 Ordering, exercise 5

spanner (noun) 1 Naming, exercise 7

staple (noun) 1 Naming, exercise 7

tail (noun) 1 Naming, exercise 2

take (verb) 2 Assembling, exercise 7

tighten (verb) 2 Assembling, exercise 7

truck (noun) 1 Naming, exercise 2

washer (noun) 1 Naming, exercise 7

wheel (noun) 1 Naming, exercise 2

yellow (adjective) 3 Ordering, exercise 5



## Unit 3

above (phrase) **3 Locations, exercise 4**  
adapter (noun) **2 Functions, exercise 1**  
alarm (noun) **2 Functions, exercise 4**  
amplifier (noun) **3 Locations, exercise 8**  
at the bottom (phrase) **3 Locations, Language**  
at the top (phrase) **3 Locations, Language**  
battery (noun) **2 Functions, exercise 1**  
below (phrase) **3 Locations, exercise 4**  
blade (noun) **1 Tools, exercise 3**  
bottle opener (noun) **1 Tools, exercise 3**  
building site (noun) **1 Tools, exercise 1**  
can opener (noun) **1 Tools, exercise 3**  
change (verb) **2 Functions, exercise 4**  
charge (verb) **2 Functions, exercise 6**  
clock (noun) **2 Functions, exercise 4**  
computer (noun) **2 Functions, exercise 11**  
computer station (noun) **3 Locations, exercise 3**  
connect (verb) **2 Functions, exercise 4**  
cover (noun) **1 Tools, exercise 7**  
cursor (noun) **3 Locations, exercise 1**  
cut (verb) **2 Functions, exercise 9**  
drive in (verb) **2 Functions, exercise 9**  
dynamo (noun) **2 Functions, exercise 1**  
electricity supply (noun) **2 Functions, exercise 4**  
external (adjective) **2 Functions, exercise 3**  
flash drive (noun) **3 Locations, exercise 8**  
generator (noun) **2 Functions, exercise 4**  
grip (verb) **2 Functions, exercise 9**  
handle (noun) **1 Tools, exercise 9**  
head (noun) **1 Tools, exercise 9**  
in the centre (phrase) **3 Locations, Language**  
in the middle (phrase) **3 Locations, Language**  
internal (adjective) **2 Functions, exercise 3**  
jaws (noun) **1 Tools, exercise 9**  
key tool (noun) **1 Tools, exercise 11**  
keyboard (noun) **3 Locations, exercise 6**  
lamp (noun) **3 Locations, exercise 7**  
mains electricity (noun) **2 Functions, exercise 1**  
measure (verb) **2 Functions, Language**  
metal (noun) **2 Functions, exercise 10**  
mouse (noun) **3 Locations, exercise 6**  
multi-tool (noun) **1 Tools, exercise 11**  
on the left (phrase) **3 Locations, Language**  
on the right (phrase) **3 Locations, Language**  
pick (noun) **1 Tools, exercise 7**  
plastic (adjective) **1 Tools, exercise 7**  
pliers (noun) **1 Tools, exercise 3**  
printer (noun) **3 Locations, exercise 8**  
produce (verb) **2 Functions, exercise 4**  
radio (noun) **2 Functions, exercise 4**  
ruler (noun) **1 Tools, exercise 8**  
scanner (noun) **3 Locations, exercise 8**  
scissors (noun) **1 Tools, exercise 3**  
screen (noun) **3 Locations, exercise 6**  
shaft (noun) **1 Tools, exercise 9**  
shine (verb) **2 Functions, exercise 6**  
solar panel (noun) **2 Functions, exercise 2**  
solar power (noun) **2 Functions, exercise 1**  
speaker (noun) **3 Locations, exercise 6**  
string (noun) **2 Functions, exercise 10**  
survival tool (noun) **1 Tools, exercise 11**  
tablet (noun) **3 Locations, exercise 8**  
to the left of (phrase) **3 Locations, exercise 4**  
to the right of (phrase) **3 Locations, exercise 4**  
torch (noun) **2 Functions, exercise 4**  
turn (verb) **2 Functions, exercise 4**  
webcam (noun) **3 Locations, exercise 3**  
wire (noun) **2 Functions, exercise 10**  
wrench (noun) **1 Tools, exercise 8**

## Unit 4

---

accelerator (noun) **3 Actions, exercise 2**  
angle (noun) **1 Directions, exercise 7**  
antenna (noun) **2 Instructions, exercise 4**  
ascend (verb) **2 Instructions, exercise 6**  
backwards (adverb) **1 Directions, exercise 2**  
brake (noun) **3 Actions, exercise 2**  
control (verb) **2 Instructions, exercise 6**  
descend (verb) **2 Instructions, exercise 6**  
direction (noun) **3 Actions, exercise 2**  
display (noun) **2 Instructions, exercise 4**  
dock (verb) **3 Actions, exercise 5**  
down (adverb) **1 Directions, exercise 8**  
drone (noun) **2 Instructions, exercise 4**  
elbow (noun) **1 Directions, exercise 7**  
forearm (noun) **1 Directions, exercise 7**  
forwards (adverb) **1 Directions, exercise 2**  
handle (noun) **2 Instructions, exercise 4**  
helicopter (noun) **1 Directions, exercise 2**  
horizontal axis (phrase) **1 Directions, exercise 3**  
joystick (noun) **2 Instructions, exercise 4**  
kilometre (noun) **2 Instructions, exercise 1**  
lever (noun) **3 Actions, exercise 2**  
metre (noun) **2 Instructions, exercise 1**  
mile (noun) **2 Instructions, exercise 1**  
movement (noun) **2 Instructions, exercise 6**  
park (verb) **3 Actions, exercise 5**  
parking brake (noun) **3 Actions, exercise 2**  
pedal (noun) **3 Actions, exercise 1**  
pivot (noun) **1 Directions, exercise 7**  
plane (noun) **2 Instructions, exercise 8**  
power switch (noun) **2 Instructions, exercise 4**  
press (verb) **3 Actions, exercise 6**  
pull (verb) **3 Actions, exercise 6**  
push (verb) **3 Actions, exercise 6**  
reverse (verb) **3 Actions, exercise 6**  
robot (noun) **1 Directions, exercise 10**  
rotate (verb) **1 Directions, exercise 5**  
rotation (noun) **2 Instructions, exercise 4**  
shoulder (noun) **1 Directions, exercise 7**  
sideways (adverb) **1 Directions, exercise 8**  
slide (verb) **2 Instructions, exercise 6**  
slow down (verb) **3 Actions, exercise 4**  
steering wheel (noun) **3 Actions, exercise 1**  
tilt (noun) **3 Actions, exercise 3**  
to the left (adverb) **3 Actions, exercise 4**  
to the right (adverb) **3 Actions, exercise 4**  
transmitter (noun) **2 Instructions, exercise 6**  
turn round (verb) **3 Actions, exercise 4**  
up (adverb) **1 Directions, exercise 8**  
vertical axis (phrase) **1 Directions, exercise 3**  
wrist (noun) **1 Directions, exercise 7**

## Unit 5

---

around (preposition of movement) **3 Cooling system, exercise 3**

battery (noun) **2 Electrical circuit, exercise 1**

blow (verb) **3 Cooling system, exercise 6**

cable (noun) **2 Electrical circuit, exercise 2**

conductor (noun) **2 Electrical circuit, exercise 1**

connect (verb) **3 Cooling system, exercise 6**

control (verb) **3 Cooling system, exercise 6**

controller (noun) **2 Electrical circuit, exercise 2**

convert (verb) **2 Electrical circuit, exercise 5**

cool (verb) **3 Cooling system, exercise 6**

drive (verb) **3 Cooling system, exercise 3**

electrical circuit (noun) **2 Electrical circuit, exercise 1**

electrical current (noun) **2 Electrical circuit, exercise 3**

energy (noun) **2 Electrical circuit, exercise 5**

engine (noun) **3 Cooling system, exercise 3**

enter (verb) **3 Cooling system, exercise 3**

fan (noun) **3 Cooling system, exercise 3**

flow (verb) **3 Cooling system, exercise 3**

go (verb) **1 Heating system, exercise 4**

heat (verb) **1 Heating system, exercise 1**

hose (noun) **3 Cooling system, exercise 3**

inlet (noun) **3 Cooling system, exercise 8**

into (preposition of movement) **3 Cooling system, exercise 3**

lamp (noun) **2 Electrical circuit, Language**

leave (verb) **1 Heating system, exercise 1**

liquid (noun) **3 Cooling system, exercise 3**

move (verb) **1 Heating system, Language**

out of (preposition of movement) **3 Cooling system, exercise 8**

pass (verb) **1 Heating system, Language**

pump (noun) **3 Cooling system, exercise 3**

push (verb) **3 Cooling system, exercise 3**

radiator (noun) **3 Cooling system, exercise 3**

rise (verb) **3 Cooling system, exercise 6**

shine (verb) **2 Electrical circuit, Language**

short-circuit (verb) **2 Electrical circuit, exercise 7**

shower head (noun) **1 Heating system, exercise 1**

sink (verb) **3 Cooling system, exercise 6**

switch (noun) **2 Electrical circuit, exercise 7**

thermostat (noun) **3 Cooling system, exercise 3**

through (preposition of movement) **3 Cooling system, exercise 8**

to (preposition of movement) **3 Cooling system, exercise 8**

valve (noun) **1 Heating system, exercise 1**

water pipe (noun) **1 Heating system, exercise 1**

water tank (noun) **1 Heating system, exercise 1**

## Unit 6

---

- alloy (noun) 2 Properties, exercise 9  
aluminium (noun) 2 Properties, exercise 9  
backpack (noun) 3 Buying, exercise 2  
bend (verb) 1 Materials testing, exercise 4  
break (verb) 1 Materials testing, exercise 1  
brittle (adjective) 2 Properties, exercise 8  
burn (verb) 2 Properties, exercise 1  
ceramic (noun) 2 Properties, exercise 9  
climb (verb) 3 Buying, exercise 6  
coat (verb) 2 Properties, exercise 9  
composite (noun) 2 Properties, exercise 9  
compress (verb) 1 Materials testing, exercise 4  
concrete (noun) 2 Properties, exercise 1  
cone (noun) 2 Properties, exercise 9  
corrode (verb) 2 Properties, exercise 7  
corrosion-resistant (adjective) 2 Properties, exercise 9  
cromoly (noun) 2 Properties, exercise 9  
dash (phrases for emails) 3 Buying, exercise 2  
diamond (noun) 2 Properties, exercise 1  
dot (phrases for emails) 3 Buying, exercise 2  
drop (verb) 1 Materials testing, exercise 4  
engine (noun) 2 Properties, exercise 9  
fibreglass (noun) 2 Properties, exercise 9  
flexible (adjective) 2 Properties, exercise 8  
frame (noun) 2 Properties, exercise 9  
graphite (noun) 2 Properties, exercise 1  
hard (adjective) 2 Properties, exercise 7  
heat (verb) 1 Materials testing, exercise 4  
heat-resistant (adjective) 2 Properties, exercise 9  
heavy (adjective) 2 Properties, exercise 8  
helmet (noun) 3 Buying, exercise 6  
hold (verb) 1 Materials testing, exercise 6  
jacket (noun) 3 Buying, exercise 2  
light (adjective) 2 Properties, exercise 9  
melt (verb) 2 Properties, exercise 1  
nylon (noun) 2 Properties, exercise 2  
piston (noun) 2 Properties, exercise 9  
plastic (noun) 2 Properties, exercise 9  
polycarbonate (noun) 2 Properties, exercise 2  
polyester (noun) 3 Buying, exercise 2  
polystyrene (noun) 2 Properties, exercise 9  
radiator (noun) 2 Properties, exercise 9  
rigid (adjective) 2 Properties, exercise 7  
rope (noun) 3 Buying, exercise 2  
rubber (noun) 2 Properties, exercise 2  
run (verb) 1 Materials testing, exercise 6  
scratch (verb) 1 Materials testing, exercise 4  
soft (adjective) 2 Properties, exercise 8  
spoiler (noun) 2 Properties, exercise 9  
steel (noun) 2 Properties, exercise 9  
stretch (verb) 1 Materials testing, exercise 4  
strike (verb) 1 Materials testing, exercise 4  
strong (adjective) 2 Properties, exercise 9  
titanium (noun) 2 Properties, exercise 2  
touch (verb) 1 Materials testing, exercise 6  
tough (adjective) 2 Properties, exercise 9  
tyre (noun) 2 Properties, exercise 9  
vehicle (noun) 2 Properties, exercise 9  
weak (adjective) 2 Properties, exercise 8  
wheel (noun) 2 Properties, exercise 9  
wing (noun) 2 Properties, exercise 9

## Unit 7

---

aluminium (noun) 2 Quantities, exercise 3  
amazing (adjective) 2 Quantities, exercise 3  
approximate (adjective) 2 Quantities, exercise 1  
attach (verb) 3 Future projects, exercise 6  
bag (noun) 2 Quantities, Language  
bottle (noun) 2 Quantities, Language  
build (verb) 3 Future projects, exercise 6  
cable (noun) 1 Dimensions, exercise 3  
cement (noun) 2 Quantities, Language  
completion (noun) 1 Dimensions, exercise 4  
compressed air (noun) 3 Future projects, exercise 3  
cubic metre (noun) 2 Quantities, exercise 2  
deck (noun) 1 Dimensions, exercise 3  
deep (adjective) 1 Dimensions, exercise 6  
depth (noun) 3 Future projects, exercise 2  
design (noun) 3 Future projects, exercise 4  
diesel (noun) 3 Future projects, exercise 3  
elevator (noun) 2 Quantities, exercise 3  
fibreglass (noun) 3 Future projects, exercise 4  
fix (verb) 3 Future projects, exercise 6  
footprint (noun) 2 Quantities, exercise 3  
foundation (noun) 3 Future projects, exercise 6  
glass (noun) 2 Quantities, exercise 3  
glue (noun) 2 Quantities, exercise 5  
height (noun) 1 Dimensions, exercise 4  
high (adjective) 1 Dimensions, exercise 6  
inner (adjective) 1 Dimensions, exercise 8  
lay (verb) 3 Future projects, exercise 6  
length (noun) 1 Dimensions, exercise 4  
location (noun) 3 Future projects, exercise 2  
long (adjective) 1 Dimensions, exercise 8  
magnetism (noun) 3 Future projects, exercise 3  
make (verb) 3 Future projects, exercise 6  
material (noun) 1 Dimensions, exercise 4  
oil (noun) 2 Quantities, Language  
outer (adjective) 1 Dimensions, exercise 4  
packet (noun) 2 Quantities, exercise 5  
paint (noun) 2 Quantities, exercise 5  
pier (noun) 1 Dimensions, exercise 3  
put (verb) 3 Future projects, exercise 6  
pylon (noun) 1 Dimensions, exercise 3  
quantity (noun) 2 Quantities, exercise 5  
reinforced concrete (noun) 2 Quantities, exercise 3  
shape (noun) 2 Quantities, exercise 3  
span (noun) 1 Dimensions, exercise 3  
specification (noun) 1 Dimensions, exercise 4  
steel (noun) 2 Quantities, exercise 3  
storey (noun) 2 Quantities, exercise 3  
structure (noun) 1 Dimensions, exercise 4  
super-fast (adjective) 2 Quantities, exercise 3  
superglue (noun) 2 Quantities, exercise 5  
tin (noun) 2 Quantities, exercise 4  
tube (noun) 2 Quantities, exercise 5  
vacuum (noun) 3 Future projects, exercise 3  
wide (adjective) 1 Dimensions, exercise 5  
width (noun) 1 Dimensions, exercise 4  
Y-shaped (adjective) 2 Quantities, exercise 3

## Unit 8

- accident (noun) **1** Recent incidents, exercise 4  
ambulance (noun) **1** Recent incidents, exercise 4  
beam (noun) **1** Recent incidents, exercise 8  
bend (verb) **2** Damage and loss, exercise 2  
body (of radio) (noun) **2** Damage and loss, exercise 3  
break (verb) **1** Recent incidents, exercise 4  
brick (noun) **1** Recent incidents, exercise 8  
bucket (noun) **1** Recent incidents, exercise 8  
builder (noun) **1** Recent incidents, exercise 8  
burn (verb) **2** Damage and loss, exercise 2  
buy (verb) **1** Recent incidents, exercise 5  
carrying bag (noun) **2** Damage and loss, exercise 3  
charging cable (noun) **2** Damage and loss, exercise 3  
check (verb) **1** Recent incidents, exercise 5  
controller (noun) **2** Damage and loss, exercise 3  
crack (verb) **2** Damage and loss, exercise 2  
crane (noun) **1** Recent incidents, exercise 8  
crash (verb) **1** Recent incidents, exercise 5  
cut (verb) **1** Recent incidents, exercise 4  
damage (noun) **2** Damage and loss, exercise 3  
dent (verb) **2** Damage and loss, exercise 2  
digger (noun) **1** Recent incidents, exercise 8  
display screen (noun) **2** Damage and loss, exercise 6  
drive (verb) **1** Recent incidents, exercise 4  
drop (verb) **3** Past events, exercise 7  
fall (verb) **1** Recent incidents, exercise 4  
fuse (noun) **1** Recent incidents, exercise 6  
global navigation (noun) **3** Past events, exercise 2  
go (verb) **3** Past events, Language  
goggles (plural) (noun) **2** Damage and loss, exercise 7  
happen (verb) **1** Recent incidents, exercise 4  
hard hat (noun) **1** Recent incidents, exercise 8  
headset (noun) **2** Damage and loss, exercise 3  
insulation (noun) **2** Damage and loss, exercise 7  
land (verb) **3** Past events, exercise 2  
launch (verb) **3** Past events, exercise 2  
lens (noun) **2** Damage and loss, exercise 7  
lose (verb) **1** Recent incidents, exercise 4  
moon (noun) **3** Past events, exercise 2  
move (verb) **1** Recent incidents, exercise 8  
order (verb) **1** Recent incidents, exercise 5  
overalls (plural) (noun) **2** Damage and loss, exercise 7  
pick up (regular) (phrasal verb) **1** Recent incidents, exercise 8  
put (verb) **1** Recent incidents, exercise 5  
put on (irregular) (phrasal verb) **1** Recent incidents, exercise 8  
raise (verb) **1** Recent incidents, exercise 8  
repair (verb) **1** Recent incidents, exercise 5  
satellite (noun) **3** Past events, exercise 2  
scaffolding (noun) **1** Recent incidents, exercise 8  
sell (verb) **1** Recent incidents, exercise 5  
send (verb) **1** Recent incidents, exercise 5  
shuttle (noun) **3** Past events, exercise 2  
sledgehammer (noun) **1** Recent incidents, exercise 8  
space station (noun) **3** Past events, exercise 2  
space walk (noun) **3** Past events, exercise 2  
spark plug (noun) **1** Recent incidents, exercise 6  
speak (verb) **1** Recent incidents, exercise 5  
steal (verb) **1** Recent incidents, exercise 5  
strap (noun) **2** Damage and loss, exercise 3  
surface (noun) **2** Damage and loss, exercise 7  
take (verb) **1** Recent incidents, exercise 4  
take off (irregular) (phrasal verb) **1** Recent incidents, exercise 8  
tear (verb) **2** Damage and loss, exercise 2  
telescope (noun) **3** Past events, exercise 2  
VR headset (noun) **2** Damage and loss, exercise 3  
write (verb) **1** Recent incidents, exercise 5

## Unit 9

- above (preposition) 1 Operation, exercise 6  
accelerate (noun) 1 Operation, exercise 6  
acceleration (noun) 1 Operation, exercise 2  
adapter (noun) 2 Hotline, exercise 3  
airboard (noun) 1 Operation, exercise 2  
attached to (preposition) 1 Operation, exercise 9  
backwards (adverb) 1 Operation, exercise 6  
battery (noun) 3 User guide, Language  
below (preposition) 1 Operation, exercise 6  
body (noun) 1 Operation, exercise 3  
brake (noun) 1 Operation, exercise 5  
cable socket (compound noun) 2 Hotline, exercise 3  
check (verb) 3 User guide, exercise 1  
circuit (noun) 1 Operation, exercise 9  
computer (noun) 2 Hotline, exercise 1  
connect (verb) 2 Hotline, exercise 3  
connected (adjective) 1 Operation, exercise 8  
connected to (preposition) 1 Operation, exercise 9  
contain (verb) 1 Operation, exercise 6  
control (verb) 1 Operation, exercise 2  
current (noun) 1 Operation, exercise 9  
cushion (noun) 1 Operation, exercise 6  
diagram (noun) 2 Hotline, exercise 8  
display (noun) 3 User guide, exercise 2  
downwards (adverb) 1 Operation, exercise 5  
drive (verb) 1 Operation, exercise 6  
engine (noun) 1 Operation, exercise 3  
fan (noun) 1 Operation, exercise 2  
fibreglass (adjective) 1 Operation, exercise 6  
flat (adjective) 3 User guide, exercise 3  
flexible (adjective) 1 Operation, exercise 6  
force (verb) 1 Operation, exercise 2  
forwards (adverb) 1 Operation, exercise 6  
friction wheel (noun) 1 Operation, exercise 6  
front (verb) 1 Operation, exercise 6  
function (noun) 1 Operation, exercise 6  
games console (compound noun) 2 Hotline, exercise 8  
handlebar (noun) 1 Operation, exercise 3  
HDMI cable (noun) 2 Hotline, exercise 8  
hold (verb) 1 Operation, exercise 6  
hotline (noun) 3 User guide, exercise 5  
hovercraft (noun) 1 Operation, exercise 6  
hub (noun) 2 Hotline, exercise 3  
increase (verb) 1 Operation, exercise 5  
key (noun) 2 Hotline, exercise 1  
LED (noun) 3 User guide, exercise 2  
lever (noun) 1 Operation, exercise 3  
mounted on (preposition) 1 Operation, exercise 9  
notebook computer (noun) 3 User guide, exercise 2  
open (verb) 3 User guide, exercise 2  
open (adjective) 3 User guide, exercise 2  
platform (noun) 1 Operation, exercise 6  
power button (compound noun) 3 User guide, Language  
power outlet (compound noun) 2 Hotline, exercise 3  
power source (compound noun) 3 User guide, exercise 2  
powerline adapter (compound noun) 2 Hotline, exercise 3  
press (verb) 3 User guide, exercise 2  
propel (verb) 1 Operation, exercise 6  
pull (air) in (phrase) 1 Operation, exercise 6  
purpose (noun) 1 Operation, exercise 7  
push (air) out (phrase) 1 Operation, exercise 6  
recharge (verb) 3 User guide, exercise 3  
release (verb) 1 Operation, exercise 6  
replace (verb) 3 User guide, exercise 3  
rider (noun) 1 Operation, exercise 3  
router (noun) 2 Hotline, exercise 3  
rubber (adjective) 1 Operation, exercise 6  
satellite dish (compound noun) 2 Hotline, exercise 8  
screen (noun) 3 User guide, exercise 3  
skirt (noun) 1 Operation, exercise 6  
speaker (noun) 3 User guide, exercise 3  
speed (noun) 1 Operation, exercise 3  
start (verb) 3 User guide, exercise 1  
starter motor (noun) 3 User guide, exercise 4  
steer (verb) 1 Operation, exercise 2  
stop (verb) 1 Operation, exercise 5  
suck (air) in (phrase) 1 Operation, exercise 6  
support (verb) 1 Operation, exercise 2  
suspended from (preposition) 1 Operation, exercise 9  
switch (verb) 1 Operation, exercise 9  
switch off (phrase) 3 User guide, exercise 5  
switch on (phrase) 3 User guide, exercise 2  
touch (verb) 1 Operation, exercise 6  
turn (verb) 3 User guide, exercise 3  
upwards (adverb) 1 Operation, exercise 6  
You're welcome. (phrase) 3 User guide, exercise 5

## Unit 10

- altitude (noun) 3 Investigations, exercise 3  
aviation (noun) 3 Investigations, exercise 3  
bare (adjective) 1 Rules and warnings, exercise 5  
careful (adjective) 1 Rules and warnings, exercise 7  
chemical (noun) 1 Rules and warnings, exercise 5  
circular (adjective) 1 Rules and warnings, exercise 4  
coil (verb) 2 Safety hazards, exercise 5  
cone (noun) 2 Safety hazards, exercise 5  
distance (noun) 3 Investigations, exercise 3  
drink (noun) 2 Safety hazards, exercise 5  
factory (noun) 1 Rules and warnings, exercise 2  
fire exit (compound noun) 2 Safety hazards, exercise 5  
fire extinguisher (compound noun) 2 Safety hazards, exercise 5  
flight (noun) 3 Investigations, exercise 3  
food (noun) 2 Safety hazards, exercise 5  
gap (noun) 2 Safety hazards, exercise 2  
gear (noun) 2 Safety hazards, exercise 2  
glove (noun) 1 Rules and warnings, exercise 2  
guard (noun) 1 Rules and warnings, exercise 4  
hazard (noun) 1 Rules and warnings, exercise 4  
high-voltage (noun) 1 Rules and warnings, exercise 2  
hook (noun) 1 Rules and warnings, exercise 4  
hurt (verb) 1 Rules and warnings, exercise 6  
incident (noun) 3 Investigations, exercise 3  
injure (verb) 1 Rules and warnings, exercise 6  
investigate (verb) 3 Investigations, exercise 5  
investigation (noun) 3 Investigations, exercise 3  
land (a plane) (verb) 3 Investigations, exercise 3  
laser (noun) 1 Rules and warnings, exercise 7  
light (verb) 1 Rules and warnings, exercise 5  
liquid (noun) 2 Safety hazards, exercise 5  
lock (verb) 2 Safety hazards, exercise 5  
look out (phrasal verb) 2 Safety hazards, exercise 2  
machine (noun) 1 Rules and warnings, Language  
mandatory (adjective) 1 Rules and warnings, exercise 4  
match (noun) 1 Rules and warnings, exercise 5  
mobile phone (compound noun) 1 Rules and warnings, exercise 2  
near miss (compound noun) 3 Investigations, exercise 3  
padlock (noun) 2 Safety hazards, exercise 7  
parallel (adjective) 3 Investigations, exercise 3  
poison (noun) 1 Rules and warnings, exercise 4  
prohibit (verb) 1 Rules and warnings, exercise 4  
prohibition (noun) 1 Rules and warnings, exercise 4  
round (adjective) 1 Rules and warnings, exercise 4  
runway (noun) 3 Investigations, exercise 3  
safety (noun) 1 Rules and warnings, exercise 4  
service (verb) 1 Rules and warnings, exercise 4  
shock (noun) 3 Investigations, exercise 3  
sign (noun) 1 Rules and warnings, exercise 4  
single (adjective) 2 Safety hazards, exercise 7  
site (noun) 1 Rules and warnings, exercise 2  
slip (verb) 3 Investigations, exercise 3  
surface (noun) 1 Rules and warnings, exercise 7  
take care (phrasal verb) 1 Rules and warnings, exercise 7  
take place (phrasal verb) 3 Investigations, exercise 4  
touch (verb) 1 Rules and warnings, exercise 2  
trap (verb) 1 Rules and warnings, exercise 7  
triangular (adjective) 1 Rules and warnings, exercise 4  
trip (verb) 3 Investigations, exercise 3  
type (noun) 3 Investigations, exercise 3  
warn (verb) 1 Rules and warnings, exercise 4  
warning (noun) 1 Rules and warnings, exercise 4  
wash (verb) 1 Rules and warnings, exercise 5  
wear (verb) 1 Rules and warnings, exercise 5  
weight (noun) 1 Rules and warnings, exercise 7



## Unit 11

- alarm bell (noun) 2 Switches and relays, exercise 2  
allow (verb) 2 Switches and relays, exercise 4  
anemometer (noun) 3 Rotors and turbines, exercise 3  
armature (noun) 2 Switches and relays, exercise 6  
automatically (adverb) 3 Rotors and turbines, exercise 5  
beep (noun) 2 Switches and relays, exercise 2  
bell (noun) 2 Switches and relays, exercise 1  
blade (noun) 3 Rotors and turbines, exercise 3  
blow (verb) 3 Rotors and turbines, exercise 5  
brake (noun) 3 Rotors and turbines, exercise 3  
burglar (noun) 2 Switches and relays, exercise 4  
buzzer (noun) 2 Switches and relays, exercise 2  
cause (verb) 2 Switches and relays, exercise 4  
circuit (noun) 2 Switches and relays, exercise 4  
click (noun) 3 Rotors and turbines, exercise 5  
click (verb) 2 Switches and relays, exercise 2  
conductor (noun) 2 Switches and relays, exercise 4  
contact (noun) 1 Pistons and valves, exercise 5  
contain (verb) 3 Rotors and turbines, exercise 4  
contract (verb) 2 Switches and relays, exercise 6  
controller (noun) 3 Rotors and turbines, exercise 4  
data (noun) 3 Rotors and turbines, exercise 6  
decrease (verb) 1 Pistons and valves, exercise 3  
detect (verb) 2 Switches and relays, exercise 4  
dial tone (noun) 2 Switches and relays, exercise 2  
door bell (noun) 2 Switches and relays, exercise 2  
download (verb) 3 Rotors and turbines, exercise 5  
earth (noun) 2 Switches and relays, exercise 1  
electromagnet (noun) 2 Switches and relays, exercise 4  
electronic (adjective) 2 Switches and relays, exercise 4  
expand (verb) 1 Pistons and valves, exercise 5  
explode (verb) 1 Pistons and valves, exercise 5  
flow (verb) 1 Pistons and valves, Language  
force (verb) 1 Pistons and valves, exercise 5  
gear (noun) 3 Rotors and turbines, exercise 3  
generator (noun) 3 Rotors and turbines, exercise 3  
guard (noun) 1 Pistons and valves, exercise 5  
high pressure (noun) 1 Pistons and valves, exercise 3  
high-speed shaft (noun) 3 Rotors and turbines, exercise 4  
horn (noun) 2 Switches and relays, exercise 2  
housing (noun) 3 Rotors and turbines, exercise 3  
hub (noun) 3 Rotors and turbines, exercise 3  
increase (verb) 1 Pistons and valves, exercise 3  
inlet valve (noun) 1 Pistons and valves, exercise 1  
let (verb) 2 Switches and relays, exercise 4  
low pressure (noun) 1 Pistons and valves, exercise 3  
low-speed shaft (noun) 3 Rotors and turbines, exercise 4  
magnet (noun) 2 Switches and relays, exercise 6  
outlet valve (noun) 1 Pistons and valves, exercise 1  
overflow pipe (noun) 1 Pistons and valves, exercise 5  
passive infrared (adjective) 2 Switches and relays, exercise 4  
piston (noun) 1 Pistons and valves, exercise 1  
piston pump (noun) 1 Pistons and valves, exercise 6  
pivot (noun) 2 Switches and relays, exercise 6  
powerful (adjective) 1 Pistons and valves, exercise 5  
prevent (verb) 2 Switches and relays, exercise 4  
pump (verb) 1 Pistons and valves, exercise 5  
relay switch (noun) 2 Switches and relays, exercise 4  
rotor (noun) 3 Rotors and turbines, exercise 4  
sensor (noun) 2 Switches and relays, exercise 4  
shaft (noun) 3 Rotors and turbines, exercise 4  
signal (noun) 2 Switches and relays, exercise 4  
siren (noun) 2 Switches and relays, exercise 2  
sound (verb) 2 Switches and relays, exercise 2  
speaker (noun) 2 Switches and relays, exercise 1  
spread (verb) 1 Pistons and valves, exercise 5  
spring (noun) 1 Pistons and valves, exercise 1  
switch (noun) 2 Switches and relays, exercise 1  
tower (noun) 3 Rotors and turbines, exercise 1  
transistor (noun) 2 Switches and relays, exercise 1  
transmit (verb) 2 Switches and relays, exercise 6  
trigger (noun) 1 Pistons and valves, exercise 1  
wind turbine (noun) 3 Rotors and turbines, exercise 1  
wire (noun) 2 Switches and relays, exercise 4  
wireless transmitter (noun) 2 Switches and relays, exercise 4  
wirelessly (adverb) 2 Switches and relays, exercise 6

## Unit 12

---

approximately (adverb) **1 Data, exercise 2**  
assemble (verb) **3 Progress, exercise 1**  
astronaut (noun) **3 Progress, exercise 1**  
camera (noun) **1 Data, exercise 2**  
check (verb) **3 Progress, exercise 3**  
confirm (verb) **2 Instructions, exercise 2**  
control centre (noun) **3 Progress, exercise 3**  
controlled (adjective) **1 Data, exercise 2**  
convert (verb) **1 Data, exercise 2**  
diameter (noun) **1 Data, exercise 2**  
dismantle (verb) **3 Progress, exercise 1**  
equipment (noun) **3 Progress, exercise 1**  
helicopter (noun) **1 Data, exercise 2**  
include (verb) **1 Data, exercise 2**  
inspect (verb) **3 Progress, exercise 1**  
install (verb) **3 Progress, exercise 4**  
instrument (noun) **1 Data, exercise 2**  
laser (noun) **1 Data, exercise 2**  
laser gun (noun) **1 Data, exercise 2**  
less than (adverb) **1 Data, Vocabulary**  
lubricate (verb) **3 Progress, exercise 4**  
mass (noun) **1 Data, exercise 2**  
mast (noun) **1 Data, exercise 2**  
microphone (noun) **1 Data, exercise 2**  
million (noun) **1 Data, exercise 7**  
mobile (adjective) **1 Data, exercise 2**  
more than (adverb) **1 Data, Vocabulary**  
obstacle (noun) **1 Data, exercise 3**  
operate (verb) **1 Data, exercise 2**  
orbit (verb) **1 Data, exercise 7**  
over (adverb) **1 Data, exercise 2**  
oxygen (noun) **1 Data, exercise 5**  
photograph (noun) **3 Progress, exercise 1**  
prepare (verb) **3 Progress, exercise 1**  
progress (noun) **3 Progress, exercise 3**  
range (noun) **1 Data, exercise 2**  
range (verb) **1 Data, exercise 2**  
remain (verb) **1 Data, exercise 2**  
remove (verb) **3 Progress, exercise 1**  
replace (verb) **3 Progress, exercise 1**  
respond (verb) **2 Instructions, exercise 5**  
robot (noun) **1 Data, exercise 2**  
robot arm (noun) **1 Data, exercise 2**  
roll (verb) **2 Instructions, exercise 2**  
rotation (noun) **1 Data, exercise 3**  
rover (noun) **1 Data, exercise 2**  
scientific (adjective) **1 Data, exercise 2**  
simulation (noun) **2 Instructions, exercise 5**  
support (verb) **1 Data, exercise 2**  
surface (noun) **1 Data, exercise 2**  
suspension (noun) **1 Data, exercise 2**  
system (noun) **1 Data, exercise 2**  
titanium (noun) **1 Data, exercise 2**  
under (adverb) **1 Data, Vocabulary**  
ventilation (noun) **3 Progress, exercise 4**  
waste (noun) **3 Progress, exercise 5**  
weather station (noun) **1 Data, exercise 2**